



Haikou Yulada Trade co., Ltd.

we are specialize in Luggage Spare Parts!

www.yulafactory.com

▶▶▶▶▶ About Us

Professional Luggage Spare Parts

Haikou Yulada Trade Co., Ltd. is a professional luggage accessory manufacturer in China.

We are a manufacturer that specializes in providing all the main parts of luggage and accessories. If you deal with us, you can get all the best services: low MOQ, mix styles and colors, factory price, fast delivery, and we can help you to ship your products.

We provide pull rods, wheels, handlebars, etc., with well-equipped testing facilities and a strong technical force.

With a wide range, good quality, reasonable prices, and stylish designs, our products are extensively used in equipment accessories and other industries.

Our products are widely recognized and trusted by users and can meet continuously changing economic and social needs.

Customized items for worldwide brands are always our main business. Our design team is ready to build a new model according to your requirements. And we also have many designed and molded for your selection.

We have the best injection machines and the best engineering in our teams.

We welcome new and old customers from all over the world to contact us for future business relationships and mutual success!



Haikou yulada trade co., ltd.

▶▶▶▶▶ Our Factory



Haikou yulada trade co., ltd.



PROFESSIONAL LUGGAGE ACCESSORIES

Why Choose Us



Well-equipped testing facilities and strong technical force



Wide range, good quality, reasonable prices and stylish designs



Our products are widely recognized and trusted by users



High quality after-sales service and professional team

Haikou yulada trade co., ltd.



PROFESSIONAL LUGGAGE ACCESSORIES

MAIN PRODUCT



Luggage Trolley

Durable Luggage Trolley Handle
Telescopic
Aluminum Trolley Handle for Travel Bag



Wheels For Suitcase

Wholesale durable
luggage accessories
Detachable wheels for
suitcase



Gold Fiberglass Roman Pillar

Highly Decorative Gold
Fiberglass Roman Pillar
with Corinthian top for
sale



Luggage Locker

Durable Luggage Locker for better
safety for traveling





OUR FACTORY ADVANTAGES:

- 10+ years experience
- OEM service available
- Best after-sale service
- Strict QC system



— Fight for Future —



THE BEST WAY TO
PREDICT FUTURE IS TO
CREATE IT.



Haikou yulada trade co., ltd.



10 YEARS POWERFUL MANUFACTURER

- OEM&ODM Experience
- Professional Factory
- Stable Supply Chain

Contact Us



Luggage&bag Accessories Quality Assurance

Haikou yulada trade co., ltd.



GLOBAL TRADE

PRODUCTS ARE SOLD ALL OVER
THE WORLD AT HOME AND ABROAD

Haikou yulada trade co., ltd.



LUGGAGE WHEELS



Haikou yulada trade co., ltd.



YC-860

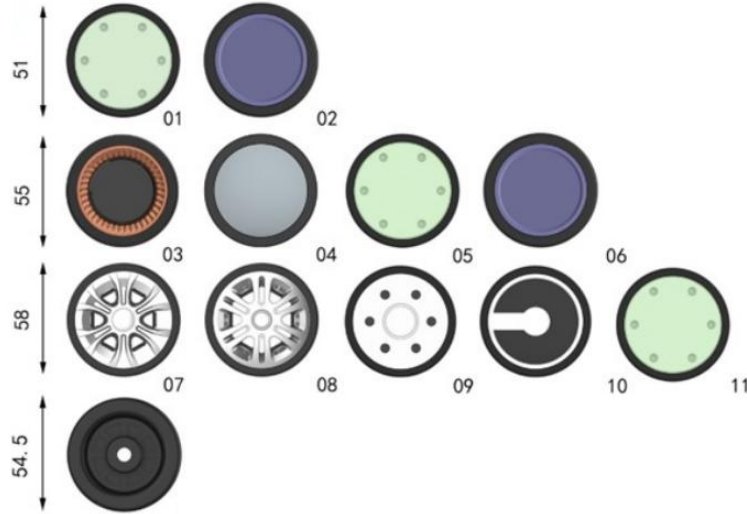
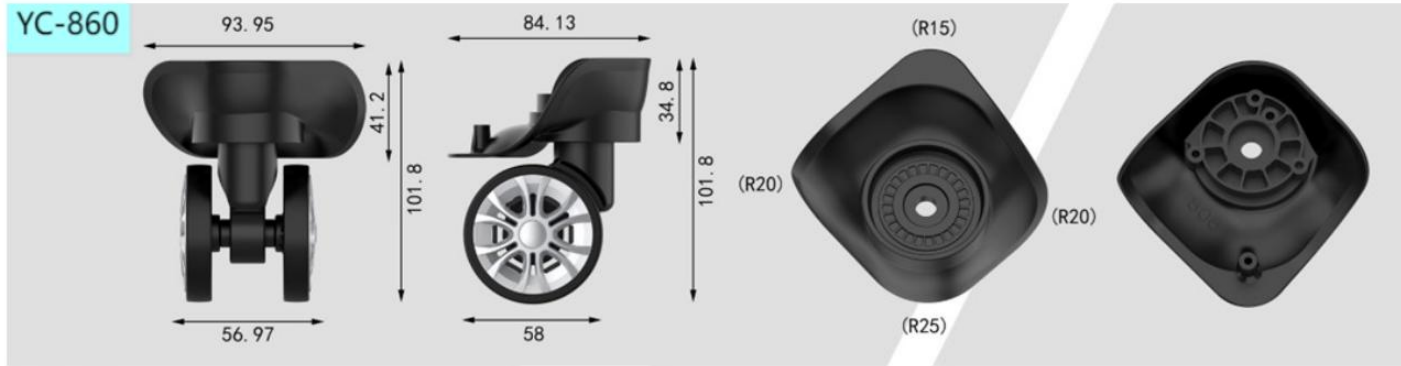



YC-771

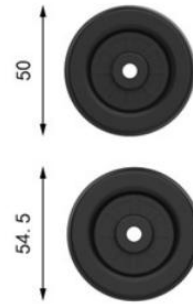
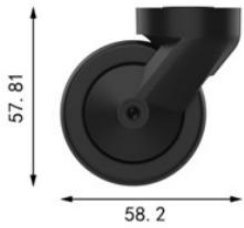
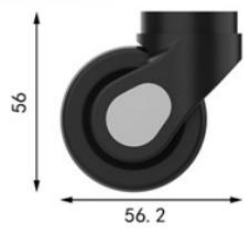
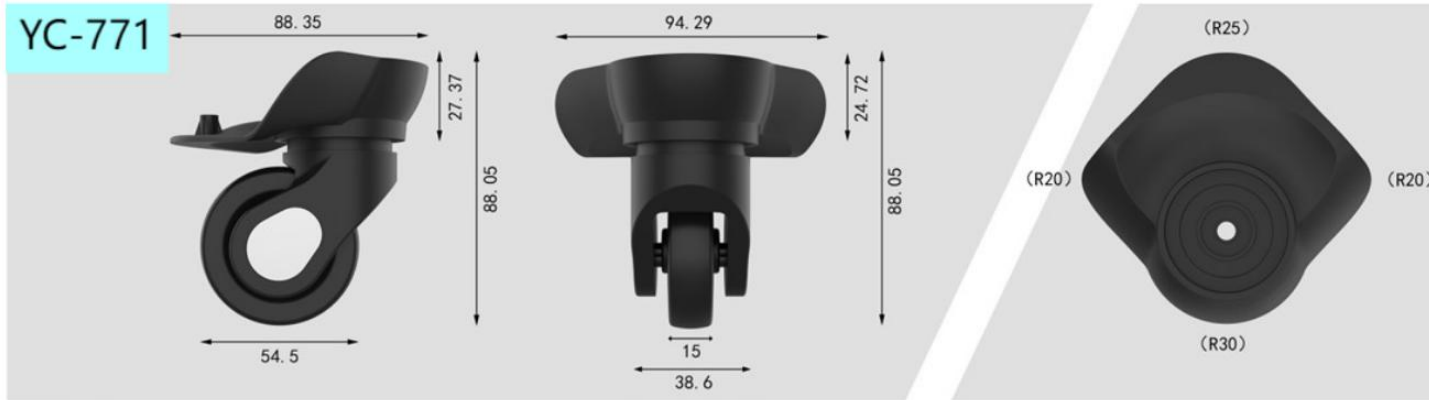



YC-8078

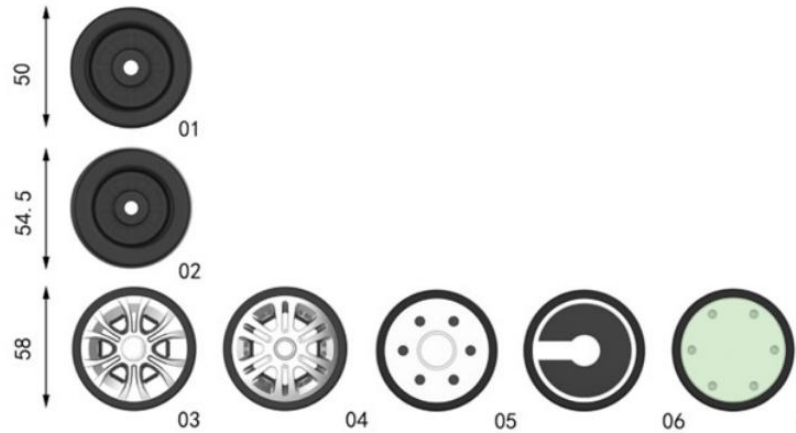
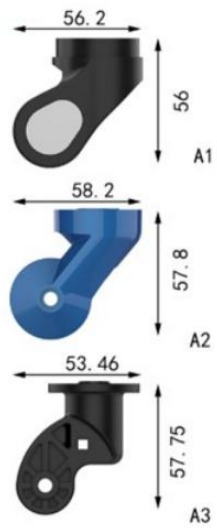



YC-7609

YC-7609

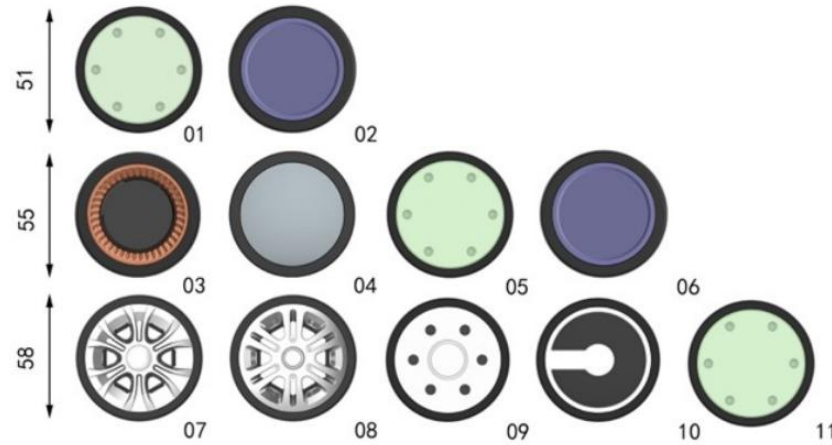
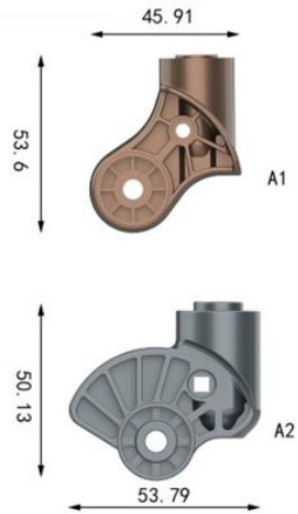
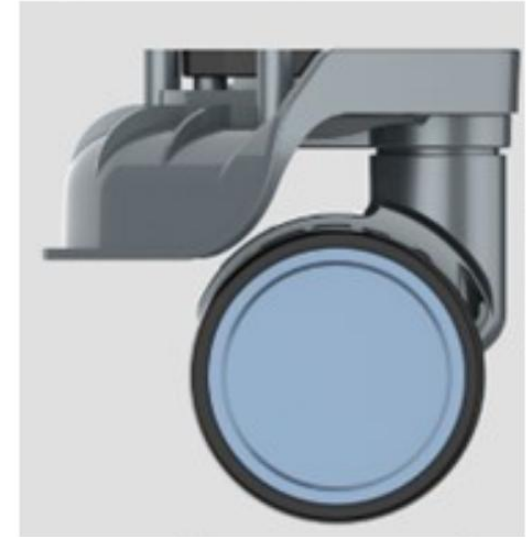
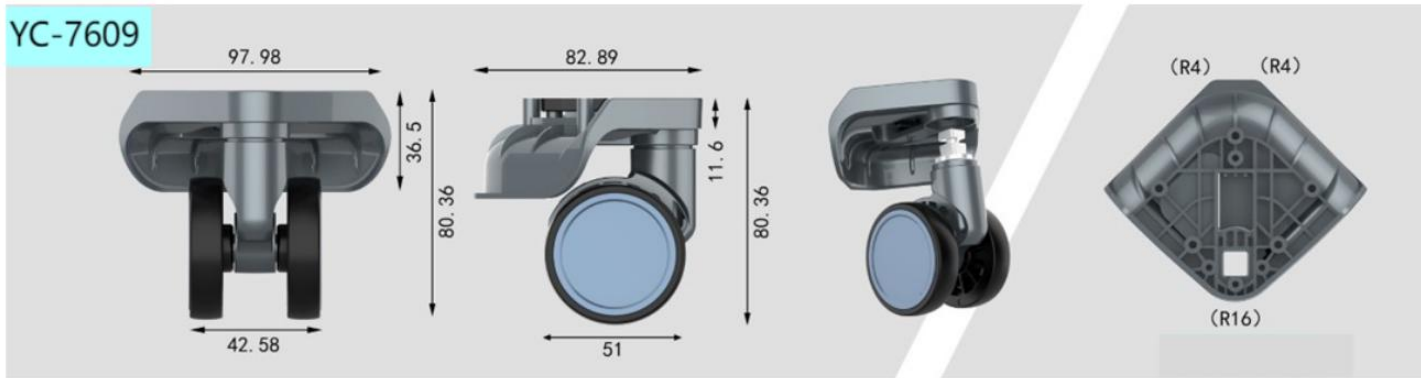

Haikou yulada trade co., ltd.



YC-7608

YC-7608

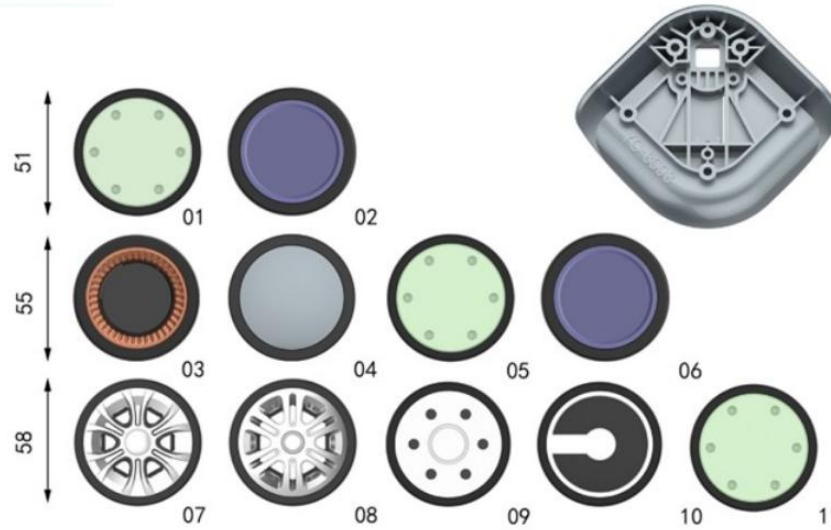
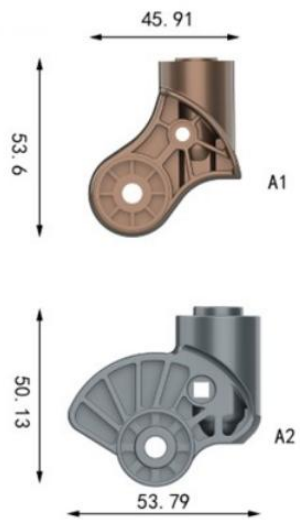

Haikou yulada trade co., ltd.



YC-8608

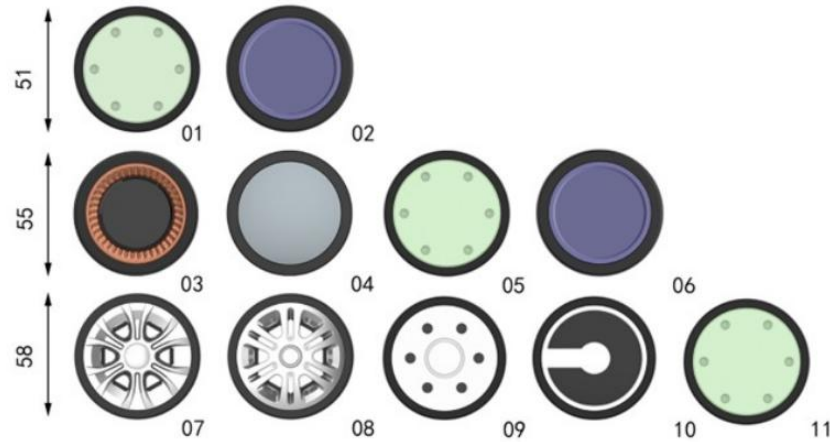
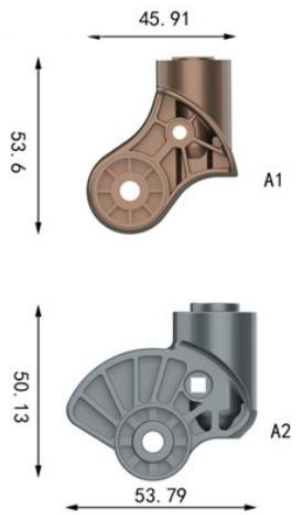
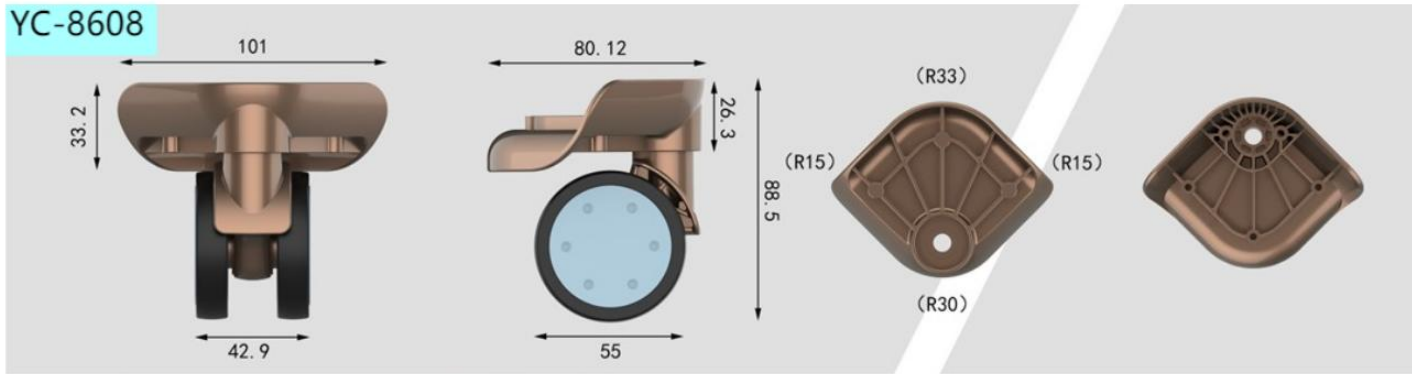



YC-8609

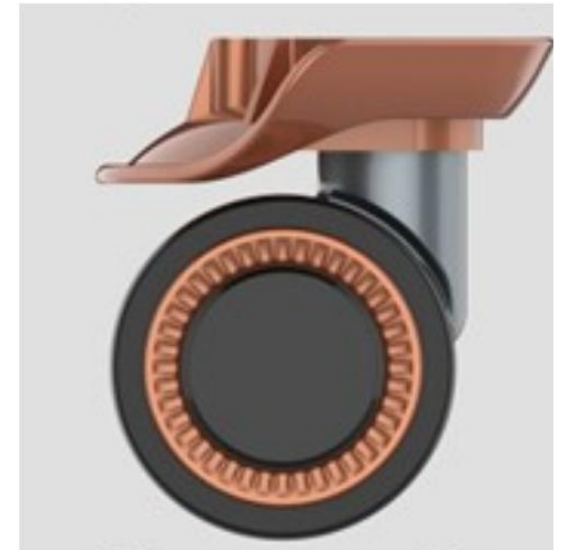
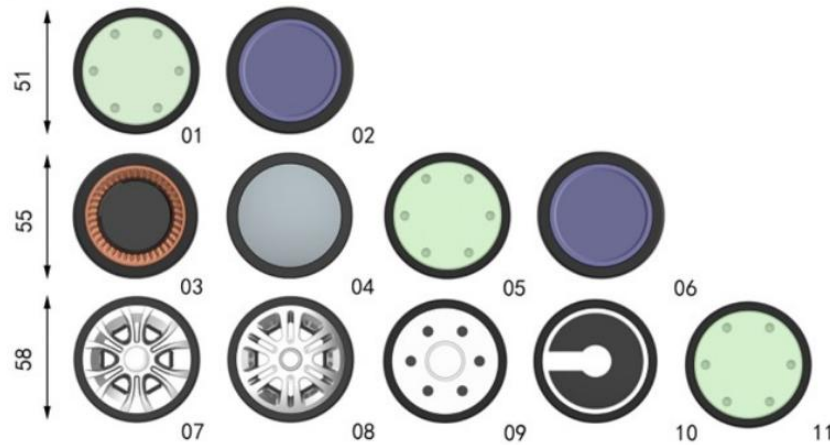
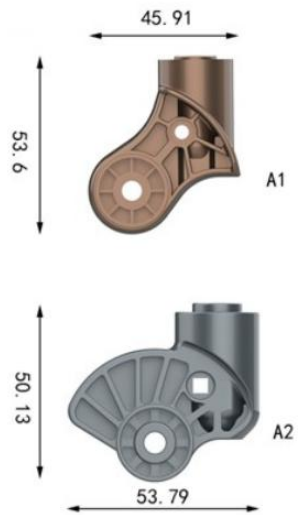
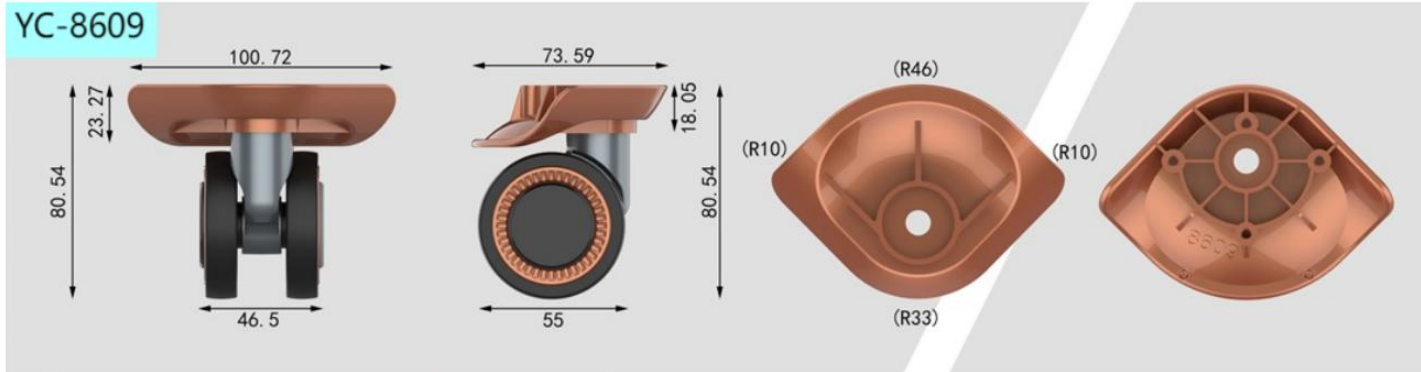



YC-8610

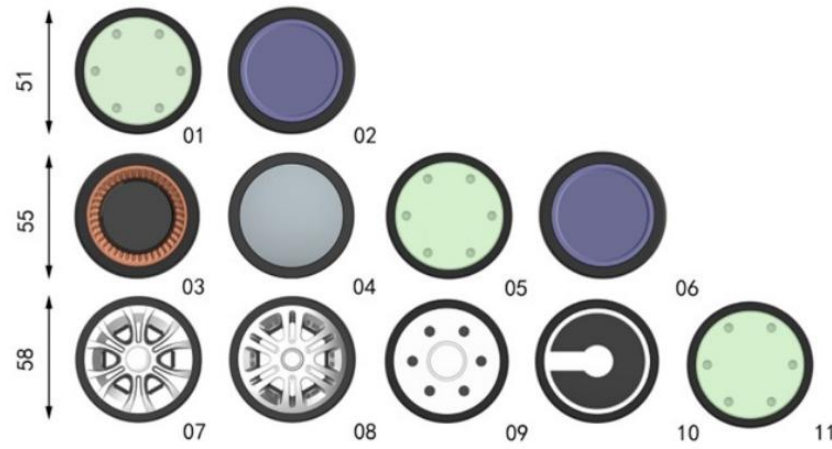
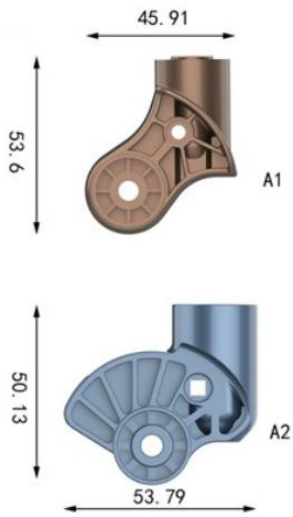
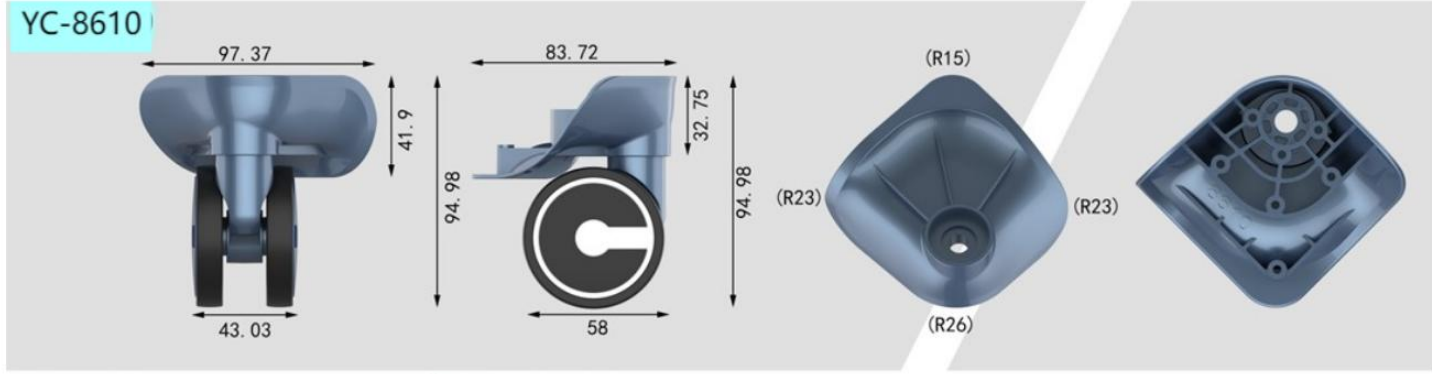

Haikou yulada trade co., ltd.



YC-8611

YC-8611

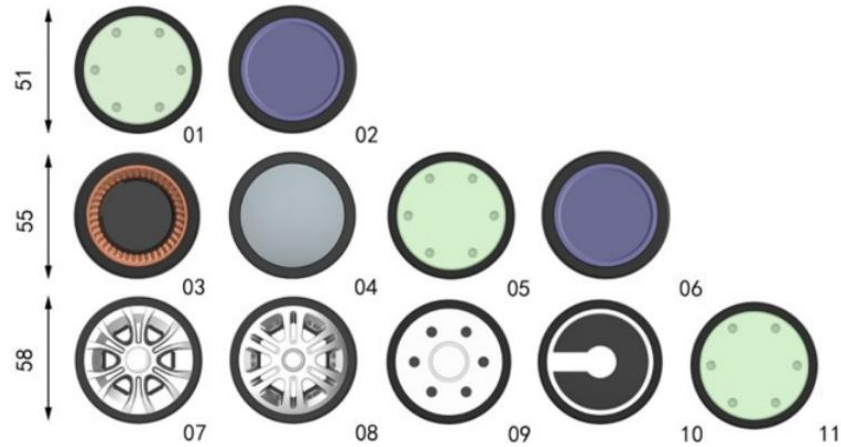
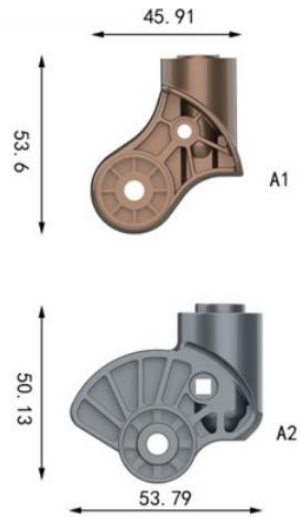
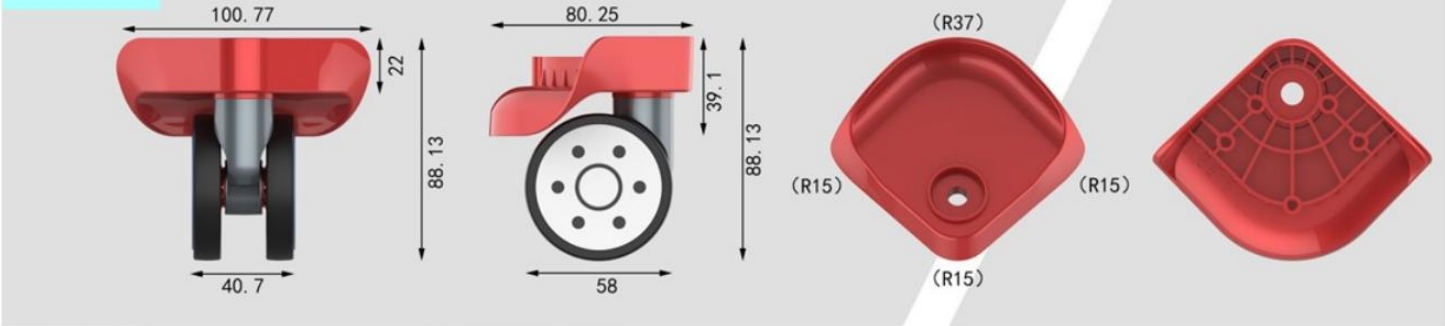

Haikou yulada trade co., ltd.



YC-8612

YC-8612

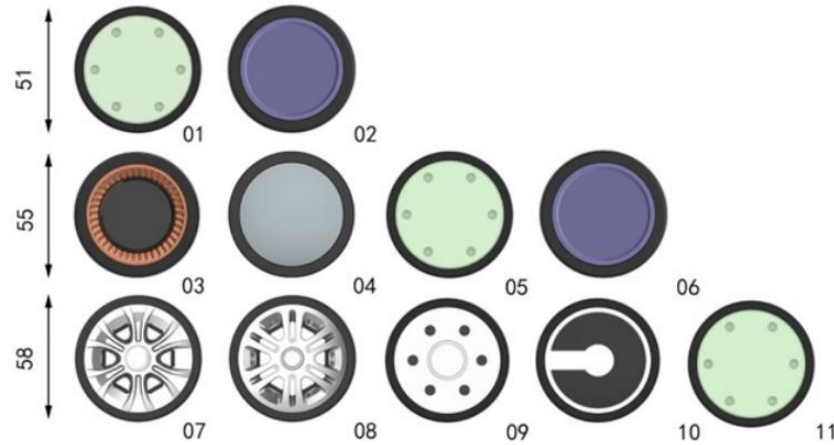
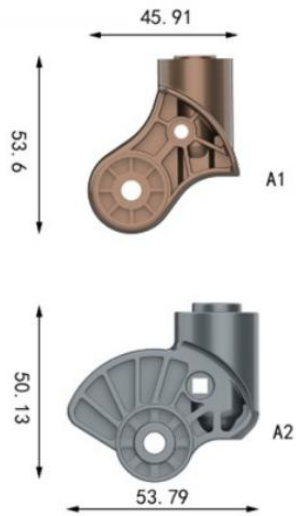
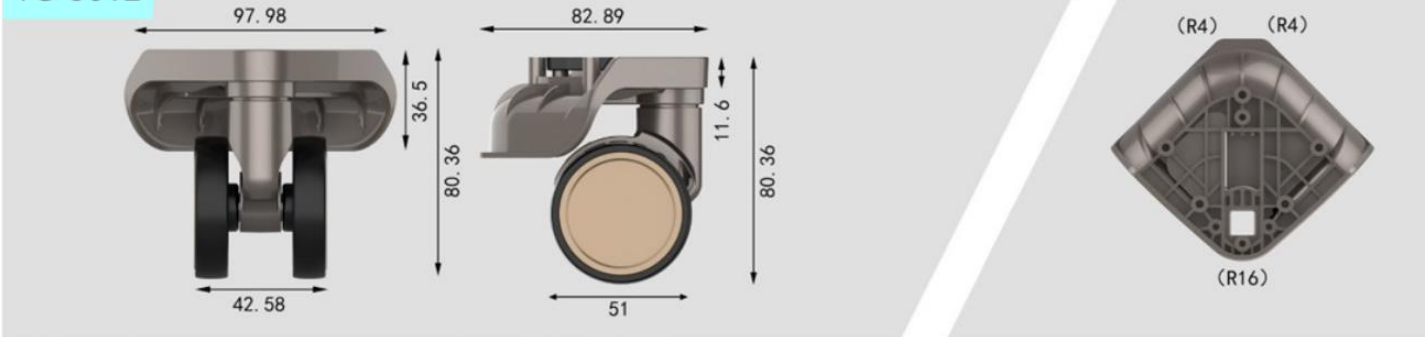

Haikou yulada trade co., ltd.



YC-8616

YC-8616

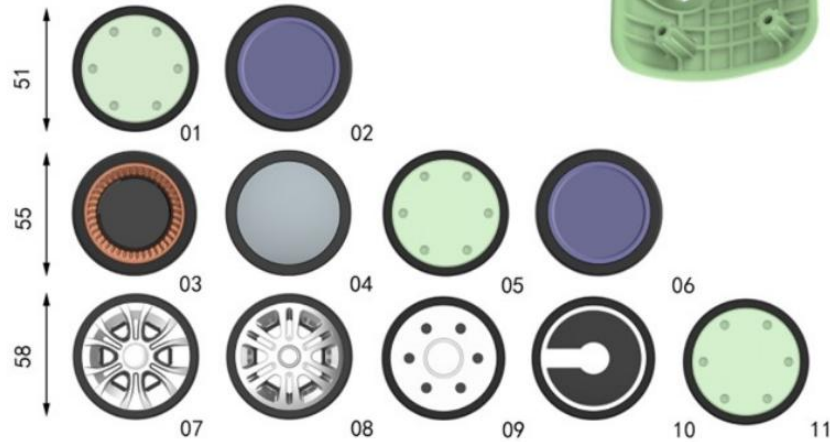
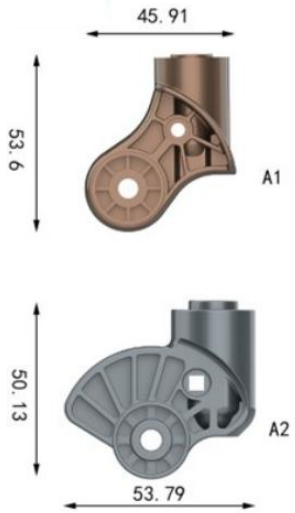
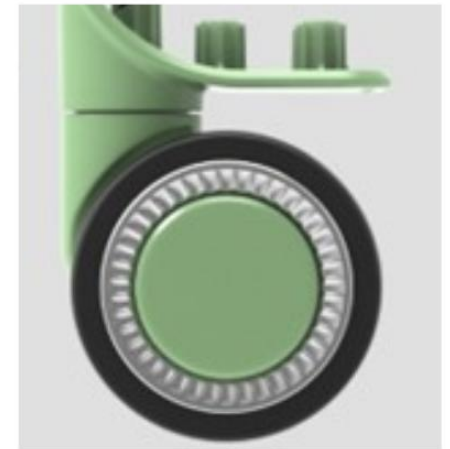
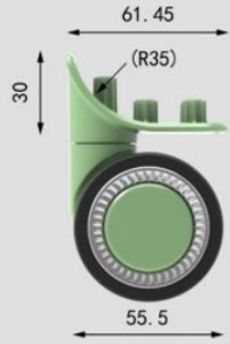
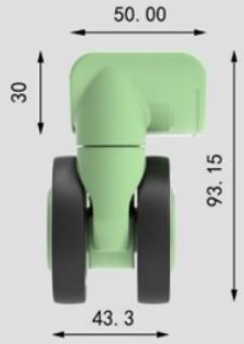

Haikou yulada trade co., ltd.



8617

YC-8617

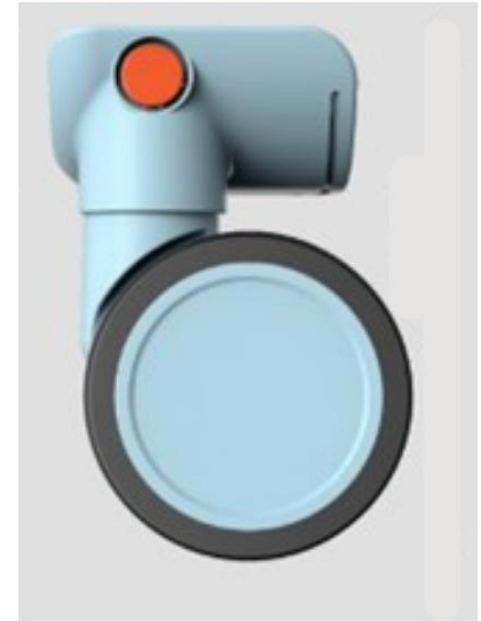
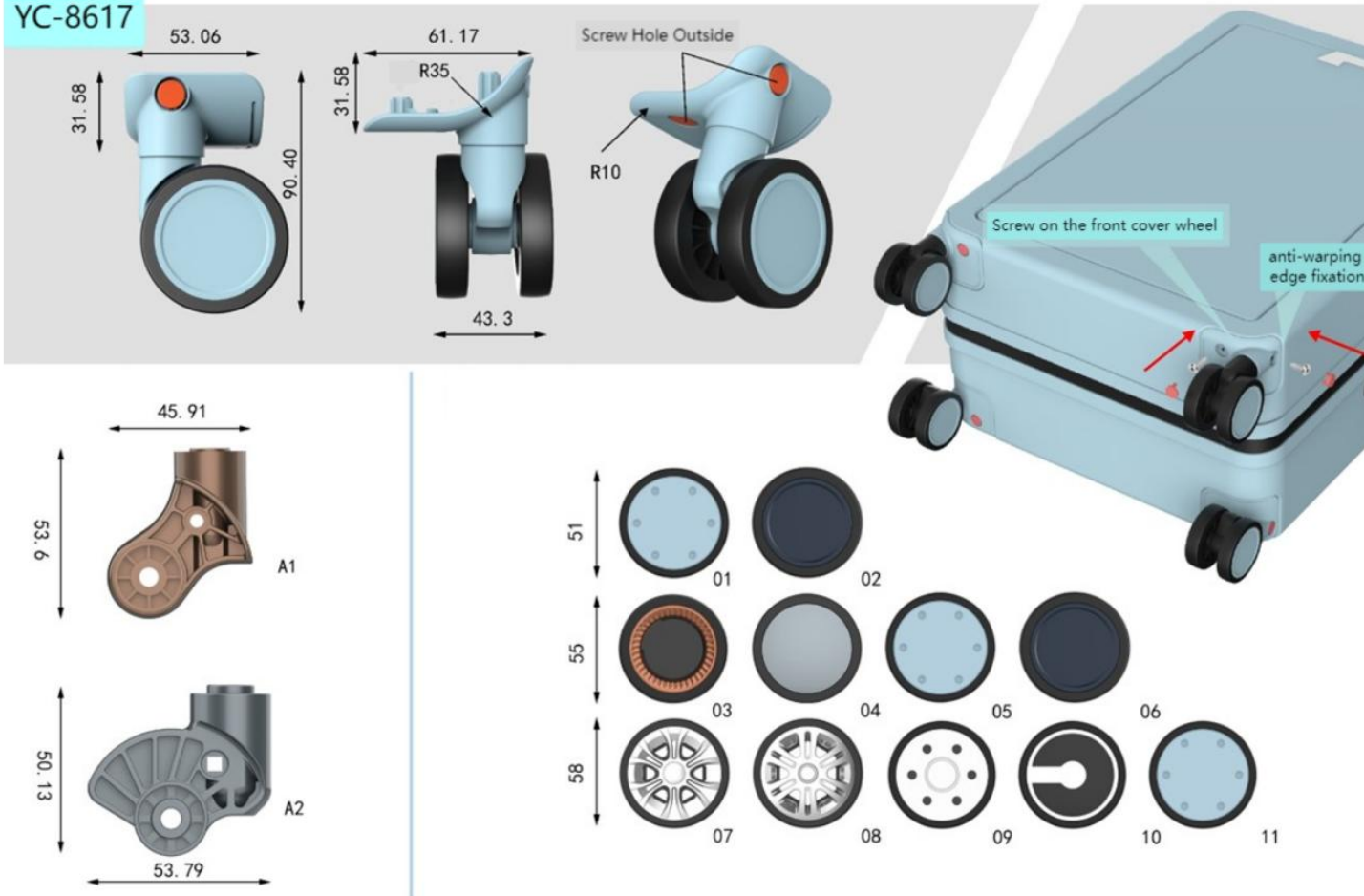

Haikou yulada trade co., ltd.



YC-8618

YC-8618

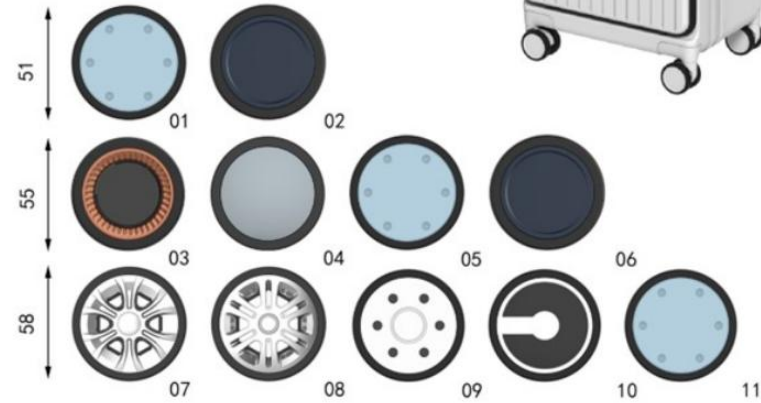
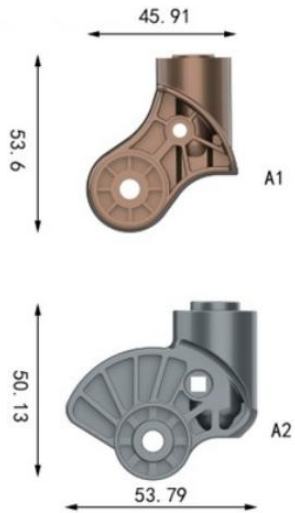
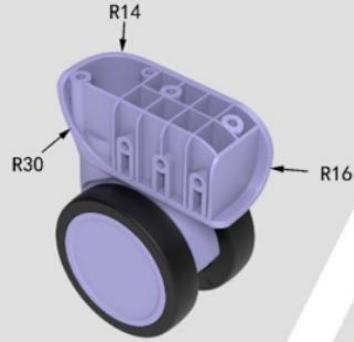
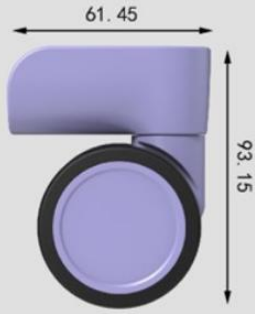

Haikou yulada trade co., ltd.



Foot Pad

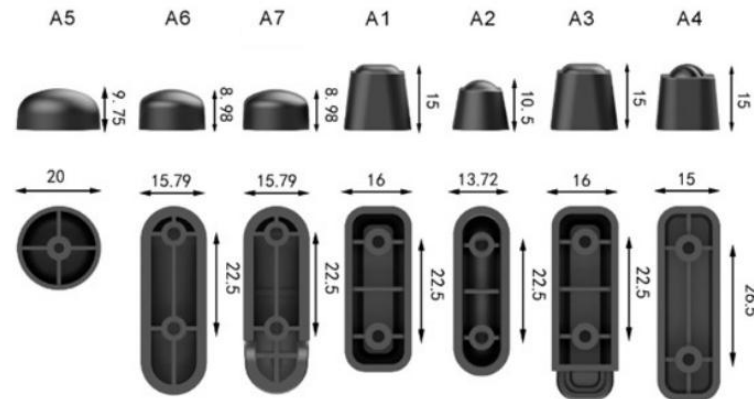
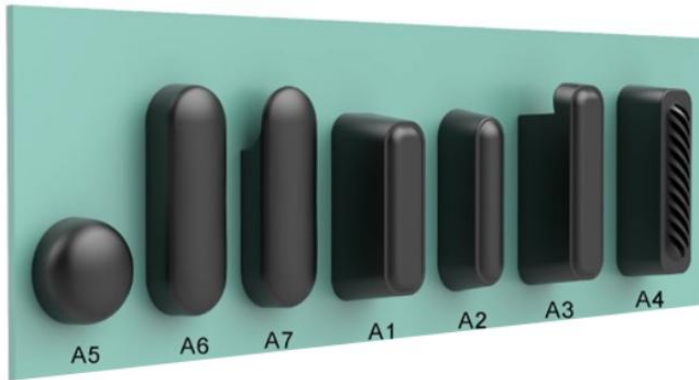
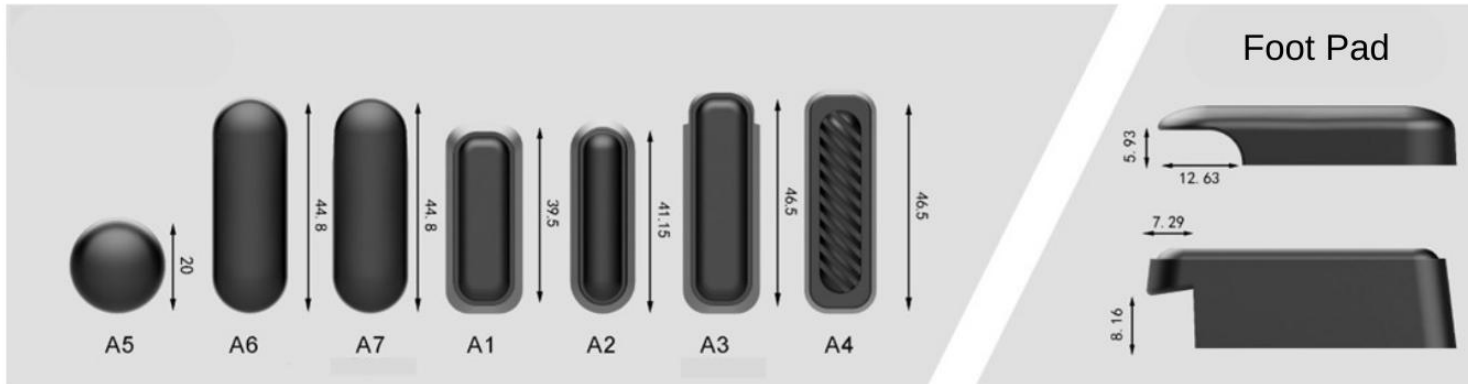



UNIVERSAL WHEEL

- Aluminum alloy rod
- Strong and durable
- Customizable
- Smooth expansion





Luggage Handle





Handle 101

101

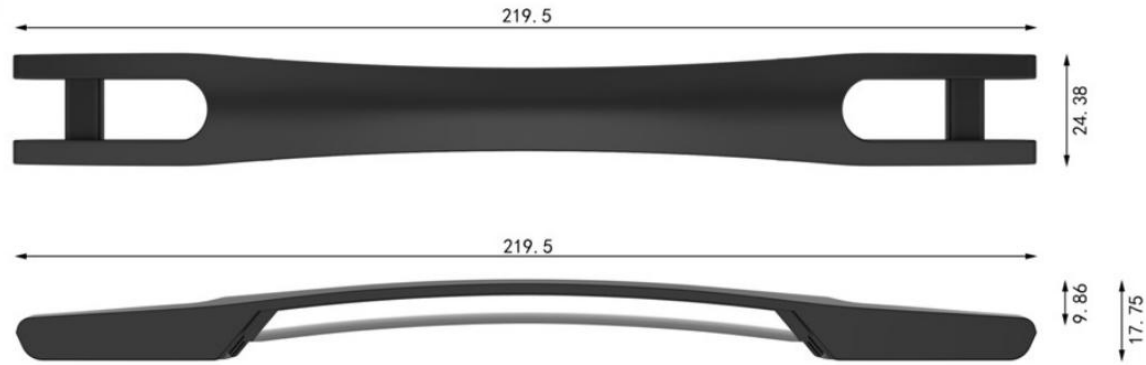

Haikou yulada trade co., ltd.



Handle 102

102

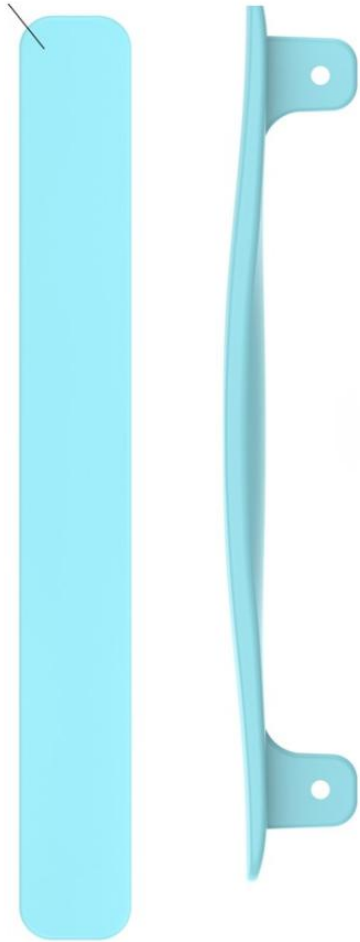
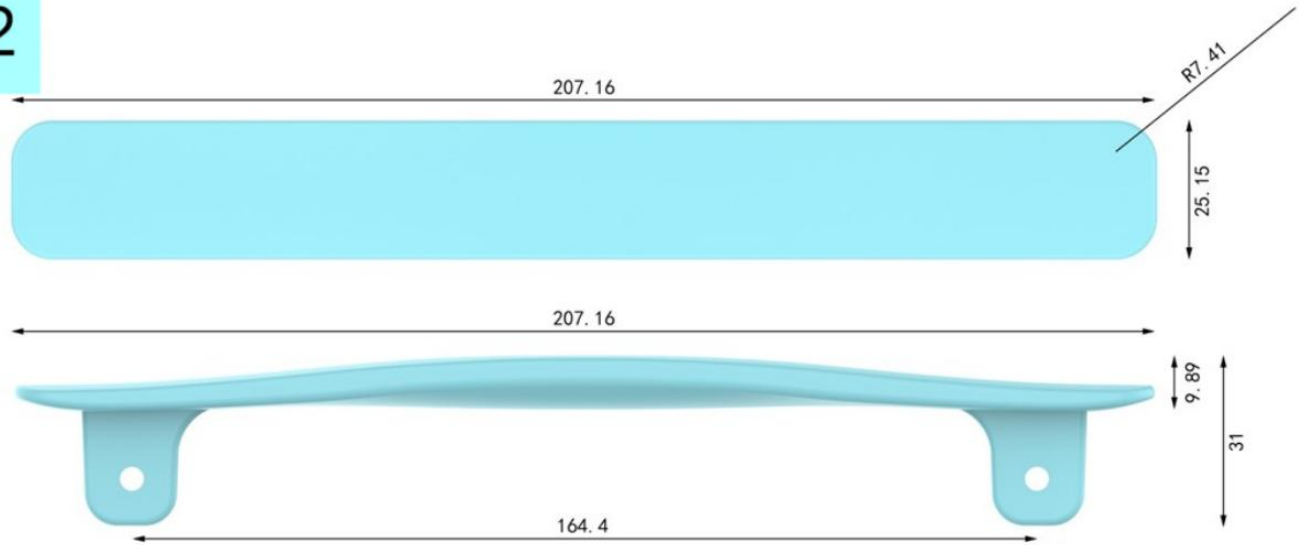

Haikou yulada trade co., ltd.



Handle 103

103

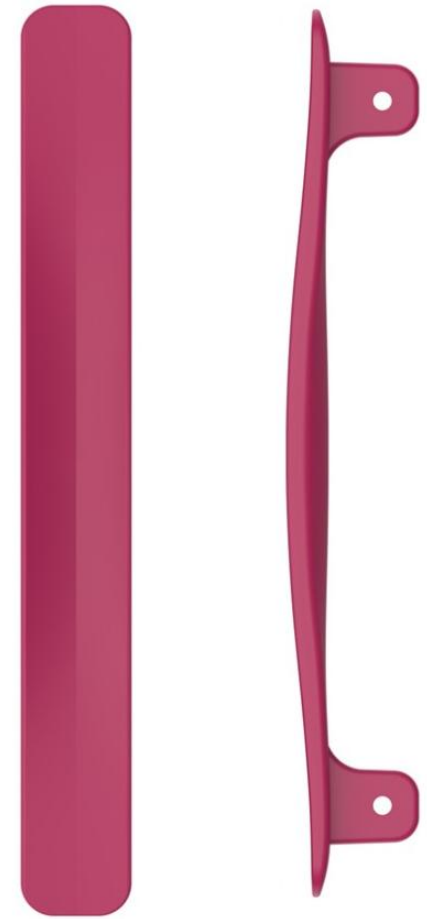
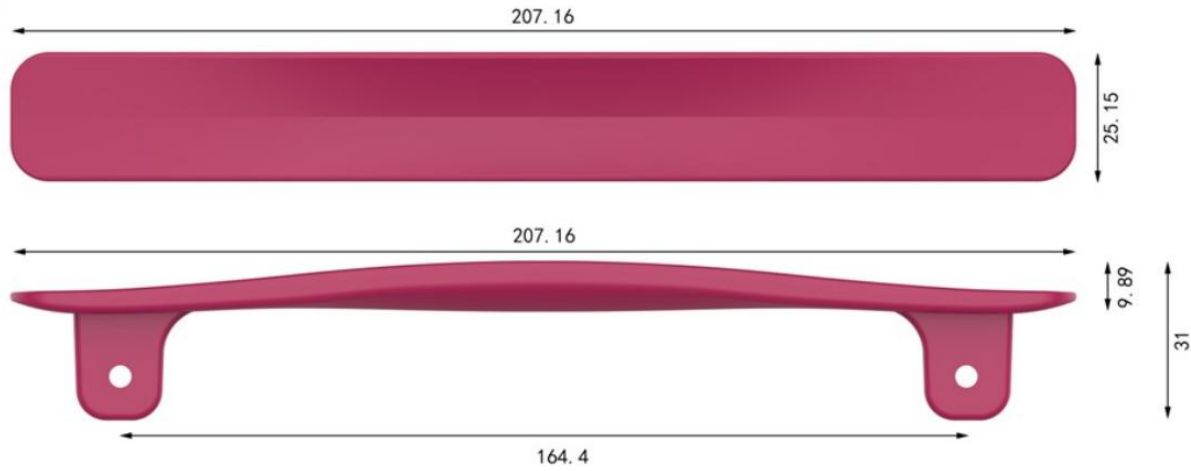

Haikou yulada trade co., ltd.



Handle 105

105

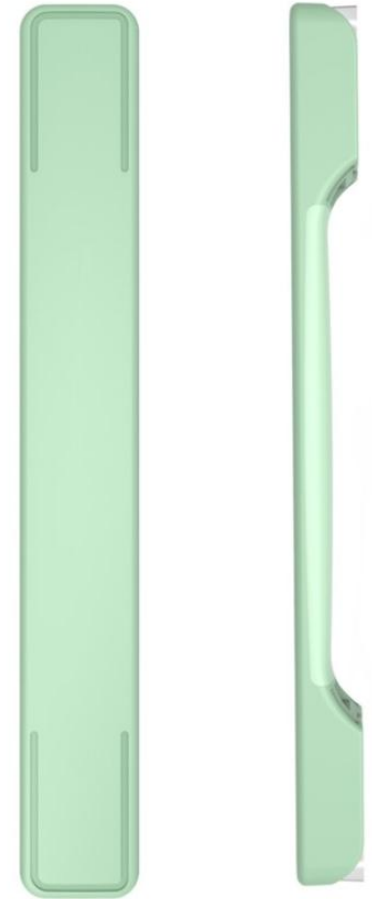
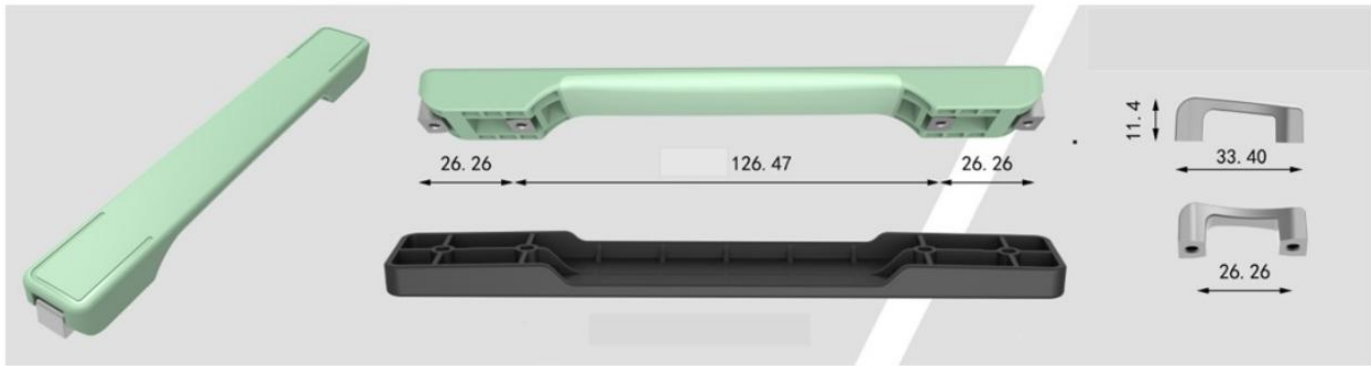
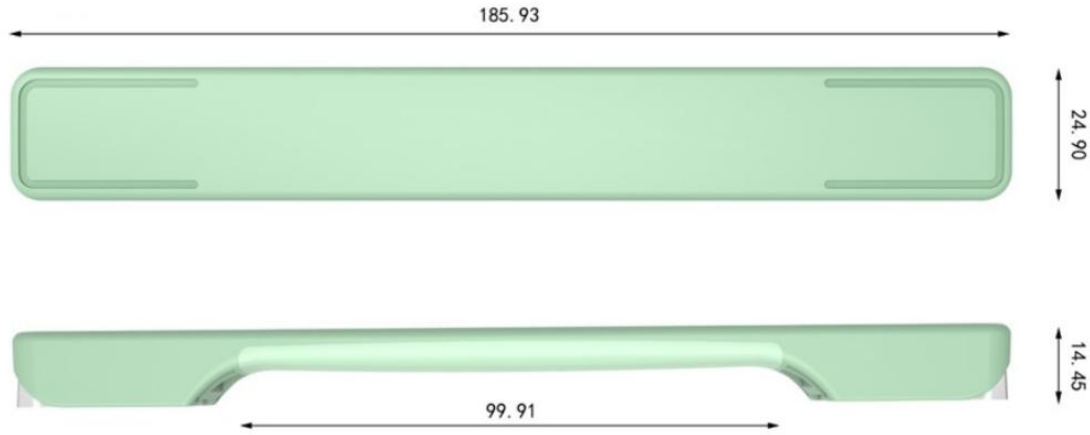

Haikou yulada trade co., ltd.



Handle 105

105

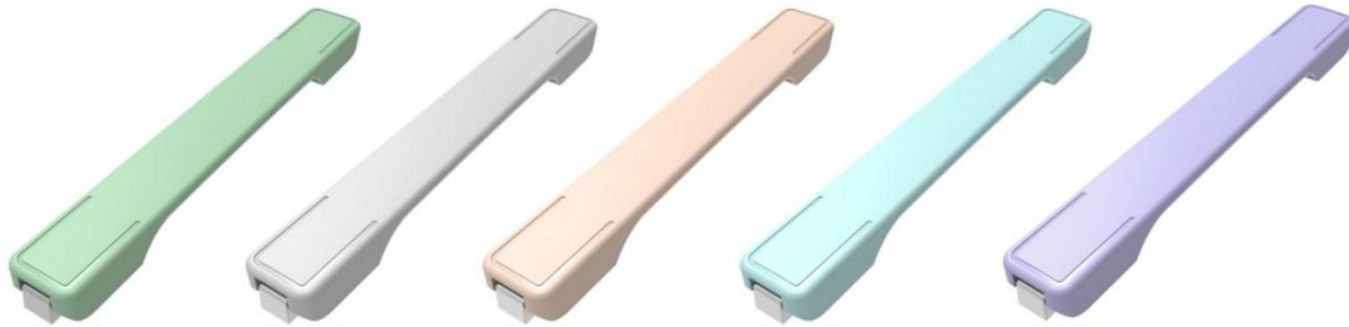

Haikou yulada trade co., ltd.



Handle 106

106

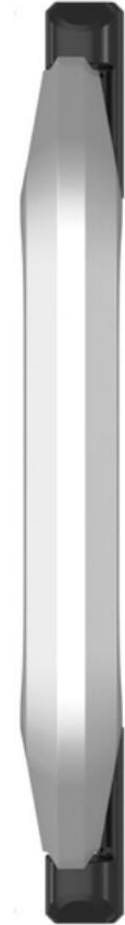
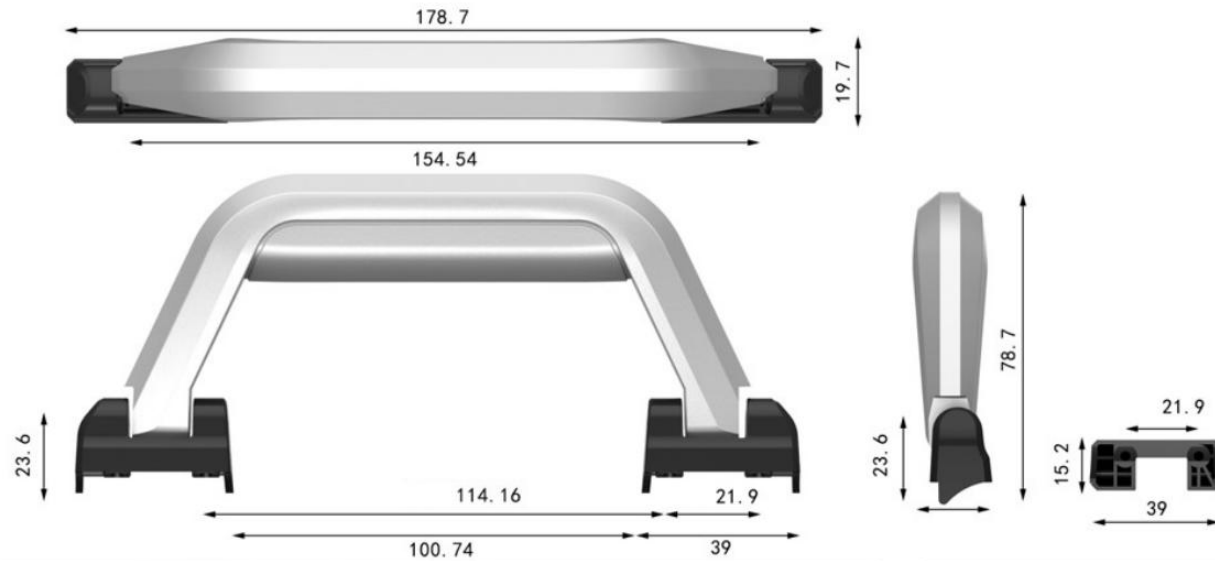

Haikou yulada trade co., ltd.



Handle 107

107

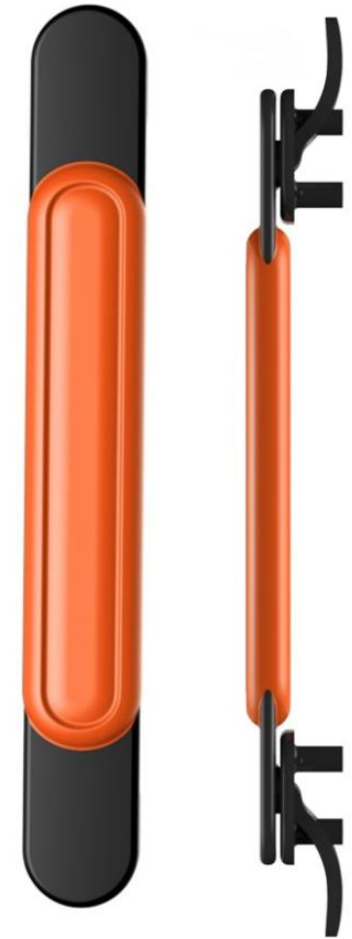
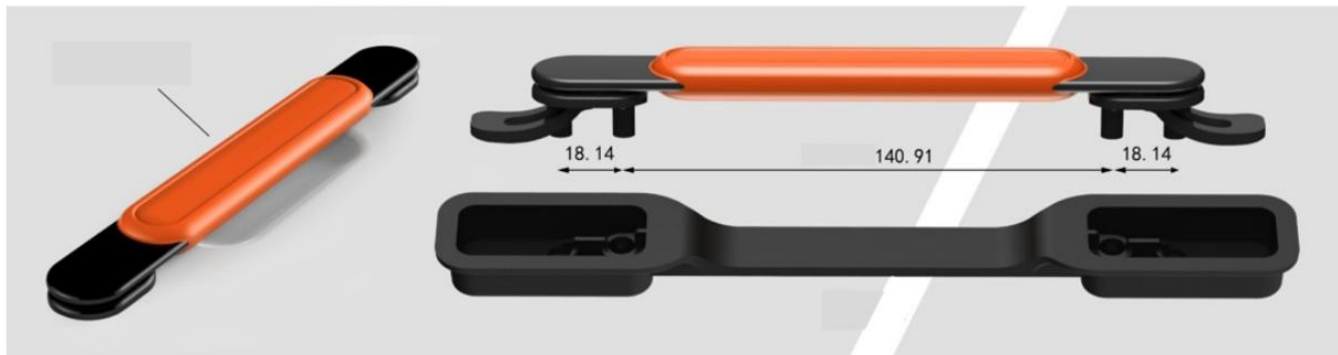
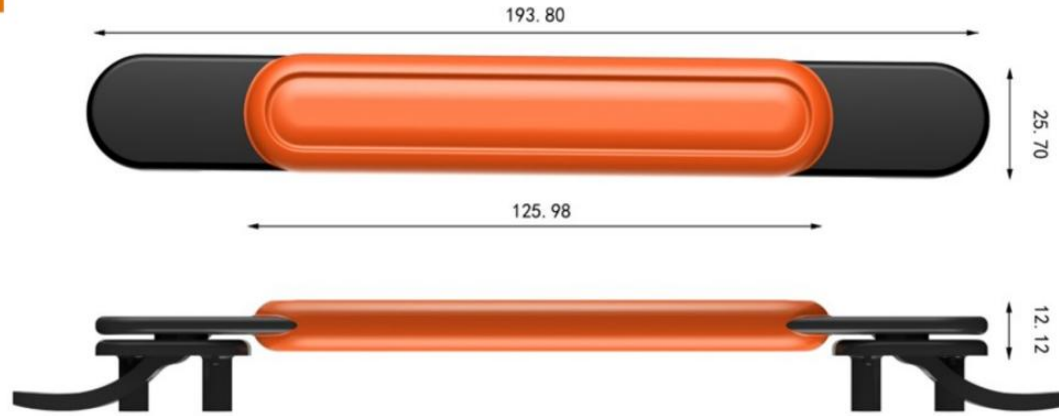

Haikou yulada trade co., ltd.



Handle 107

107

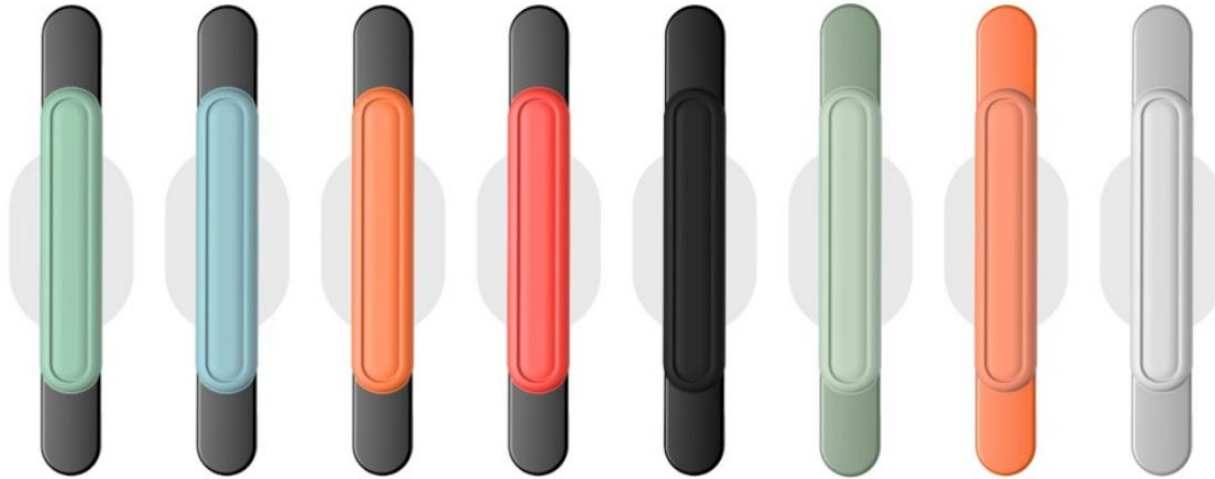

Haikou yulada trade co., ltd.



Handle 107A

107A

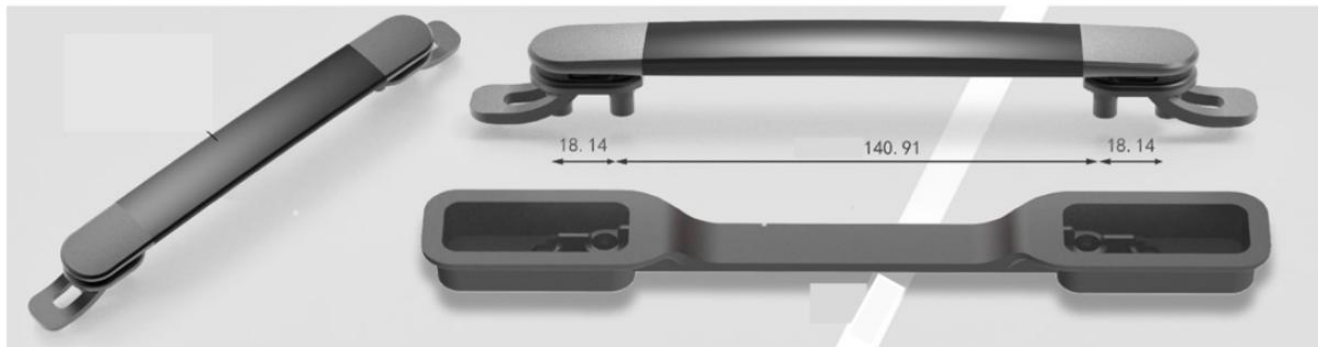
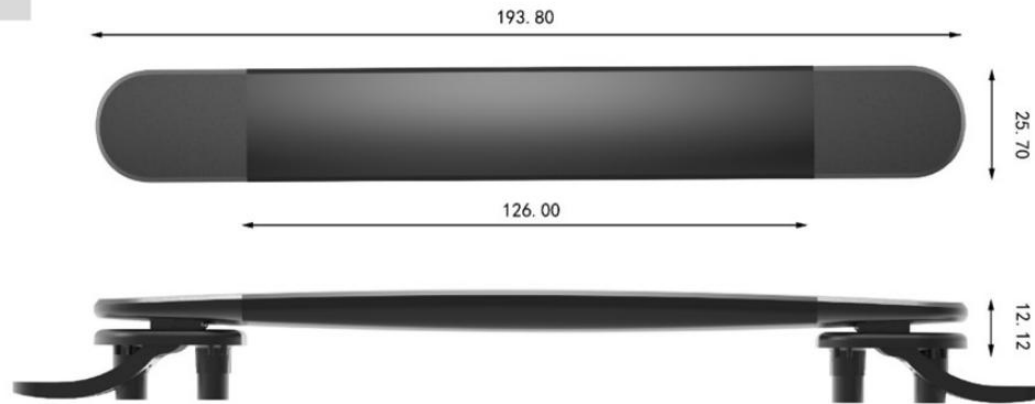

Haikou yulada trade co., ltd.



Handle 108

108

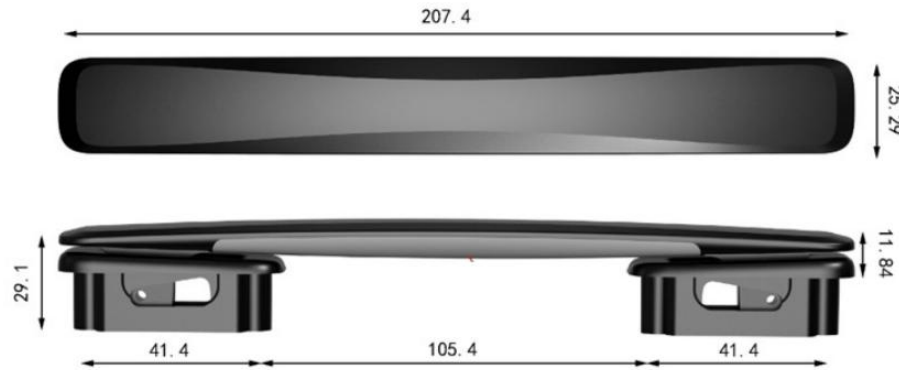

Haikou yulada trade co., ltd.

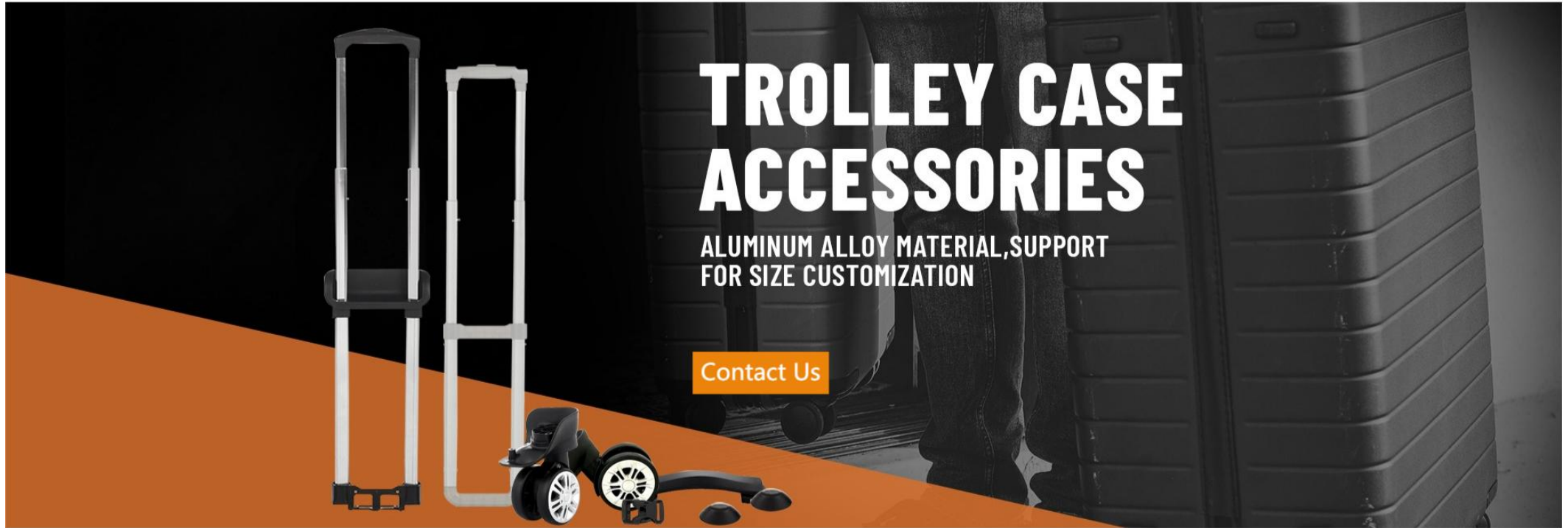

TROLLEY CASE ACCESSORIES

ALUMINUM ALLOY MATERIAL, SUPPORT
FOR SIZE CUSTOMIZATION

Contact Us

Haikou yulada trade co., ltd.



Part Of Trolley

firm and durable aluminum alloy high-quality internal trolley handle
smooth telescope, save room and convenient to use.



Haikou yulada trade co., ltd.



Tube Shape



Butterfly



Saquare(Aluminum)

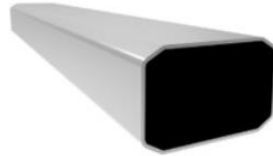

Square(Iron)



Oval



Rectangle



Rectangle 2

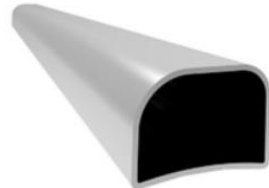

Half Round

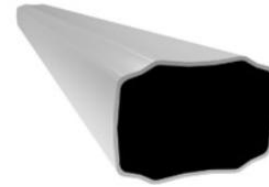

Octagon



T Shape



Bullet Shape

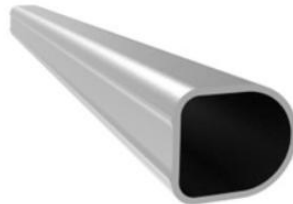

D Shape



Trolley Handle Model





Trolley Handle Model





706+Bullet Tube



Bullet Shape Tube

(ITEM NO) : Bullet tube mm
(section) : 2 /3
(small tube) : 20.6*12.6
(middle tube) : 24*16
(outside tube) : 27.8*19.9



(Outside tube : iron/aluminum)



706+Bullet Tube 2



706+Bullet Tube 3



706+Bullet Tube



Haikou yulada trade co., ltd.



507+Bullet Tube



Bullet Shape Tube

(ITEM NO) : Bullet Tube mm
(section) : 2 / 3
(small tube) : 20.6*12.6
(middle tube) : 24*16
(outside tube) : 27.8*19.9



(Outside tube : iron/aluminum)



507+210+Bullet Tube 2



507+Bullet Tube 3



507+210+Bullet Tube



507+Bullet Tube





708+Bullet Tube



Bullet Shape Tube

(ITEM NO) : Bullet Tube mm
(section) : 2 / 3
(small tube) : 20.6*12.6
(middle tube) : 24*16
(outside tube) : 27.8*19.9



(Outside tube : iron/aluminum)



708+Bullet Tube 2



708+Bullet Tube 3



708+Bullet Tube



Haikou yulada trade co., ltd.



A7002+Bullet Tube



Bullet Shape Tube

(ITEM NO) : Bullet Tube mm
(section) : 2 /3
(small tube) : 20.6*12.6
(middle tube) : 24*16
(outside tube) : 27.8*19.9



(Outside tube : iron/aluminum)



A7002+210+Bullet Tube 2



A7002+Bullet Tube 3

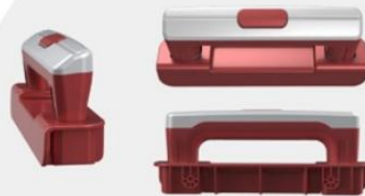

A7002+210+Bullet Tube



A7002+Bullet Tube



Haikou yulada trade co., ltd.



1902+210+Bullet Tube



Bullet Shape Tube

(ITEM NO) : Bullet Tube mm
(section) : 2 /3
(small tube) : 20.6*12.6
(middle tube) : 24*16
(outside tube) : 27.8*19.9



(Outside tube : iron/aluminum)



1902+210+Bullet Tube 2



1902+210+Bullet Tube 3



1902+210+Bullet Tube



R:17



Haikou yulada trade co., ltd.



209+210+Bullet Tube



Bullet shape Tube

(ITEM NO) : Bullet Tube mm
(section) : 2 /3
(small tube) : 20.6*12.6
(middle tube) : 24*16
(outside tube) : 27.8*19.9



(Outside tube : iron/aluminum)



209+210+Bullet Tube 2



209+210+Bullet Tube 3



209+210+Bullet Tube



Haikou yulada trade co., ltd.



2403+D Shape Tube



D Shape Tube

(ITEM NO) D Shape Tube mm
(section): 2 / 3 / 4
(small tube): 18.6*6
(middle tube): 23.7*20
(large tube): 26.6*24
(large tube): 31.7*28



2403+ D Tube 2



2403+ D Tube 3



2403+ D Tube 4



USB Charging+Phone Holder



(Outside tube: iron/aluminum)



2403+D Tube(USB+ Phone Holder)

Haikou yulada trade co., ltd.



2206+ Half Round Tube



(ITEM NO) : Half Round Tube mm
(section) : 2 /3
(small tube) : 16.12*9.1
(middle tube) : 19.8*13.1
(outside tube) : 23.86*17.21



2206+Half Round 2

2206+Half Round 3

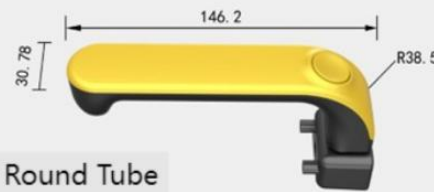

2206+Half Round Tube

Haikou yulada trade co., ltd.



506+Half Round Tube



(ITEM NO) : Half Round Tube mm
(section) : 2 /3 /4
(small tube) : 16.12*9.1
(middle tube) : 19.8*13.1
(large tube) : 23.86*17.21
(outside tube) : 27.74*21.41



506+t+Half Round 2



506+t+Half Round 3



506+t+Half Round 4



(Outside tube : aluminum)



506+t+Half Round Tube

R:25



Haikou yulada trade co., ltd.



507+Half Round Tube

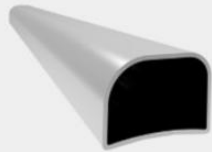

Half Round Shape

(ITEM NO) : Half Round Tube mm
(section) : 2 /3 /4
(small tube) : 16.12*9.1
(middle tube) : 19.8*13.1
(large tube) : 23.86*17.21
(outside tube) : 27.74*21.41



(Outside tube : aluminum)



507+v+Half Round 2 507+t+Half Round 3 507+t+Half Round 4

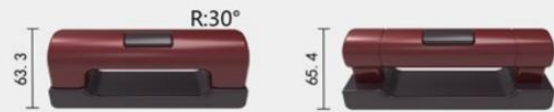

507+v+Half Round Tube 507+t+Half Round Tube





A7002+q+Btterfly Tube

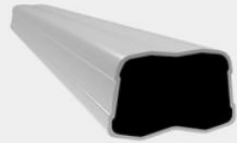

Butterfly Shape Tube

(ITEM NO) : Butterfly Shape Tube mm
(section) : 2 /3
(small tube) : 21.65*12.05
(middle tube) : 25.8*16.1
(outside tube) : 30.1*20.1



(Outside tube : aluminum)



A7002+q+ Butterfly Tube 2



A7002+q+ Butterfly Tube 3



A7002+q+Butterfly Tube



Haikou yulada trade co., ltd.



806+q+Btterfly Tube

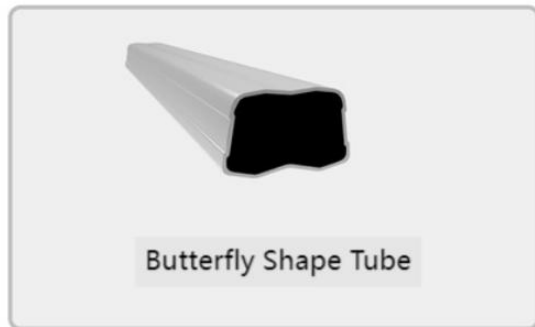

(ITEM NO) : Butterfly Shape mm
(section) : 2 /3
(small tube) : 21.65*12.05
(middle tube) : 25.8*16.1
(outside tube) : 30.1*20.1

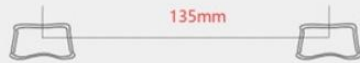

(Outside tube : aluminum,



806+q+Butterfly Tube 2



806+q+Butterfly Tube 3



806+q+Butterfly Tube



Haikou yulada trade co., ltd.



805+h+Oval Tube



(ITEM NO) : Oval Tube mm
(section) : 2 /3 /4
(small tube) : 19.6*11.9
(middle tube) : 22.7*15
(large tube) : 26.7*19.0
(outside tube) : 31*29



805+h+Oval Tube 2



805+h+Oval Tube 3



805+h+Oval Tube 4



(Outside tube : iron)



805+h+Oval Tube

R:40



Haikou yulada trade co., ltd.



605+h+Oval Tube



Oval Tube

(ITEM NO) : Oval Tube mm
(section) : 2 /3 /4
(small tube) : 19.6*11.9
(middle tube) : 22.7*15
(large tube) : 26.7*19.0
(outside tube) : 31*29



(Outside tube : iron)



605+h+Oval Tube 2



605+h+Oval Tube 3



605+h+Oval Tube 4



605+h+Oval Tube

R:40



Haikou yulada trade co., ltd.



96+c+T Tube



T Tube

(ITEM NO) : T Tube mm
(section) : 2 /3
(small tube) : 20*13
(middle tube) : 23*18
(large tube) : 26*23
(outside tube) : 29*28



(Outside tube : iron/aluminum)



96+c+T 2



96+c+T 3



96+c+T Tube

R:40



Haikou yulada trade co., ltd.



97+T Tube

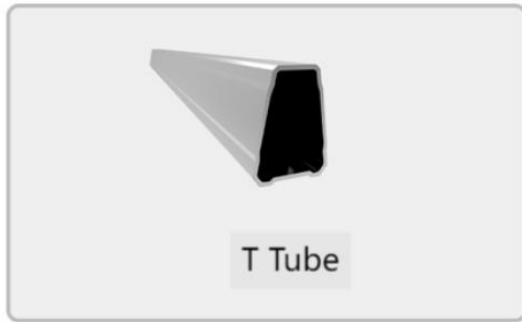

T Tube

(ITEM NO) : T Tube mm
(section) : 2 /3 /4
(small tube) : 20*13
(middle tube) : 23*18
(large tube) : 26*23
(outside tube) : 29*28

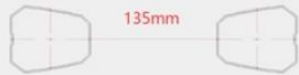

(Outside tube : iron/aluminum)



97+c+T 2



97+c+T 3



97+c+T 4



97+a+T Tube



97+c+T Tube

R:40



Haikou yulada trade co., ltd.



98+T Tube

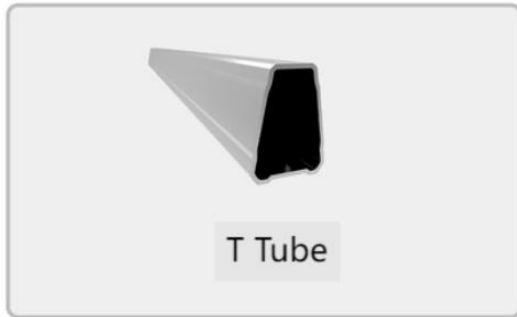

T Tube

(ITEM NO) : T Tube mm
(section) : 2 /3 /4
(small tube) : 20*13
(middle tube) : 23*18
(large tube) : 26*23
(outside tube) : 29*28

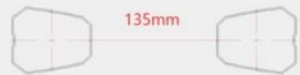

(Outside tube : iron/aluminum)



98+a+T 2



98+a+T 3



98+a+T 4

R:35



98+a+ T Tube



98+c+ T Tube



Haikou yulada trade co., ltd.



99+T Tube

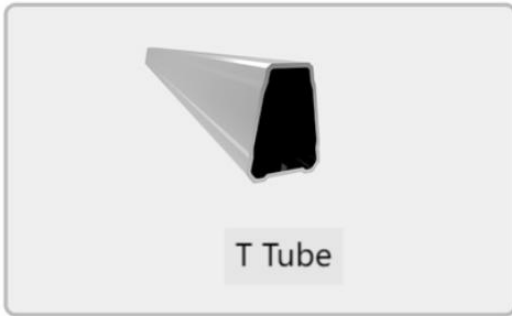

T Tube

(ITEM NO) : T Tube mm
(section) : 2 /3 /4
(small tube) : 20*13
(middle tube) : 23*18
(large tube) : 26*23
(outside tube) : 29*28

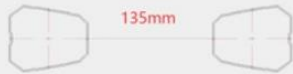

(Outside tube : iron/aluminum)



99+a+T 2



99+a+T 3



99+a+T 4



99+a+T Tube



99+c+T Tube



Haikou yulada trade co., ltd.



305+Square Tube

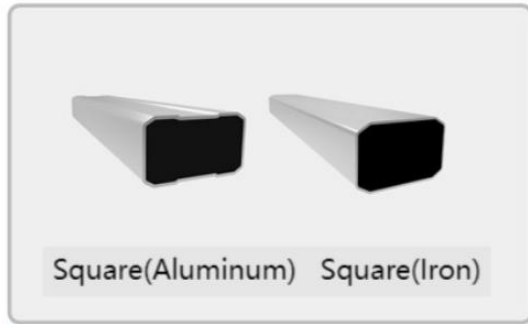

Square(Aluminum) Square(Iron)

(ITEM NO) : Square Tube mm
(section) : 2 /3 /4
(small tube) : 8.9*18.4
(middle tube) : 12.5*22
(large tube) : 16.1*25.6
(outside tube) : 19.7*29.2

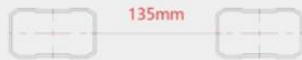

(Outside tube : aluminum)



305+g+Square 2



305+g+Square 3



305+g+Square 4



305+g+Square Tube



305+k+Square Tube

R:25





306+p+Square Tube

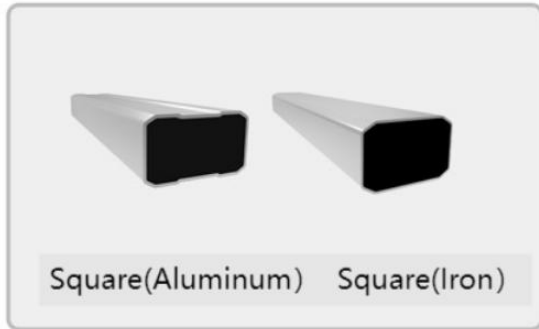

Square(Aluminum) Square(Iron)

(ITEM NO) : Square Tube mm
(section) : 2 /3 /4
(small tube) : 8.9*18.4
(middle tube) : 12.5*22
(large tube) : 16.1*25.6
(outside tube) : 19.7*29.2



(Outside tube : aluminum)



306+p+Square 2



306+p+Square 3



306+p+Square 4

R:40



306+p+Square Tube



Haikou yulada trade co., ltd.



308+p+Square Tube

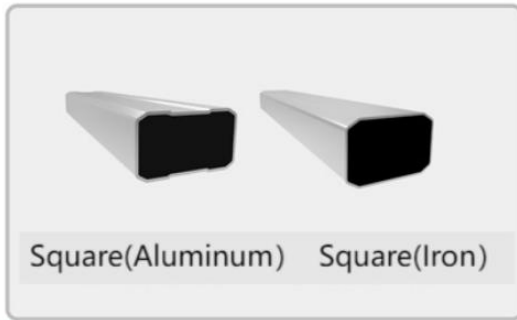

Square(Aluminum) Square(Iron)

(ITEM NO) : Square Tube mm
(section) : 2 /3 /4
(small tube) : 8.9*18.4
(middle tube) : 12.5*22
(large tube) : 16.1*25.6
(outside tube) : 19.7*29.2



(Outside tube : aluminum)



308+p+Square 2



308+p+Square 3



308+p+Square 4

R:40



308+p+Square Tube



Haikou yulada trade co., ltd.



703+Octagon Tube



Octagon Tube

(ITEM NO) : Octagon Tube mm
(section) : 2 /3 /4
(small tube) : 19.4*9.9
(middle tube) : 23.2*13.7
(large tube) : 27*17.5
(outside tube) : 30.6*21.1



(Outside tube : iron/aluminum)



703+k+Octagon Tube 2



703+k+Octagon Tube 3



703+k+Octagon Tube 4



703+d+Octagon Tube



703+u+Octagon Tube



703+g+Octagon Tube



703+i+Octagon Tube



703+k+Octagon Tube



703+r+Octagon Tube



Haikou yulada trade co., ltd.



705+Octagon Tube



Octagon Tube

(ITEM NO) : Octagon Tube mm
(section) : 2 /3 /4
(small tube) : 19.4*9.9
(middle tube) : 23.2*13.7
(large tube) : 27*17.5
(outside tube) : 30.6*21.1



705+k+Octagon Tube 2 705+k+Octagon Tube 3 705+k+Octagon Tube 4



(Outside tube : iron/aluminum)



705+g+Octagon Tube



705+k+Octagon Tube

R:25



Haikou yulada trade co., ltd.



702+Octagon Tube

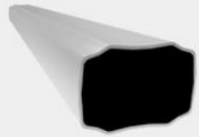

Octagon Tube

(ITEM NO) : Octagon Tube mm
(section) : 2 /3
(small tube) : 19.4*9.9
(middle tube) : 23.2*13.7
(large tube) : 27*17.5
(outside tube) : 30.6*21.1



(Outside tube : iron/aluminum)



702+u+Octagon Tube 2



702+u+Octagon Tube 3



702+d+Octagon Tube



702+u+Octagon Tube



702+r+Octagon Tube



702+i+Octagon Tube



702+k+Octagon Tube



702+g+Octagon Tube



Haikou yulada trade co., ltd.



706+Octagon Tube

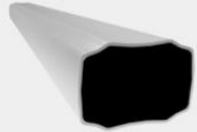

Octagon Tube

(ITEM NO) : Octagon Tube mm
(section) : 2 /3 /4
(small tube) : 19.4*9.9
(middle tube) : 23.2*13.7
(large tube) : 27*17.5
(outside tube) : 30.6*21.1



(Outside tube : iron/aluminum)



706+u+Octagon Tube 2



706+u+Octagon Tube 3



706+u+Octagon Tube 4



706+d+Octagon Tube



706+u+Octagon Tube

R:40





707+Octagon Tube



(ITEM NO) : Octagon Tube mm
(section) : 2 /3
(small tube) : 19.4*9.9
(middle tube) : 23.2*13.7
(large tube) : 27*17.5
(outside tube) : 30.6*21.1



(Outside tube : iron/aluminum)



707+d+Octagon Tube 2

707+d+Octagon Tube 3



707+d+Octagon Tube

R:15°



707+u+Octagon Tube

R:25°



707+g+Octagon Tube

R:25°



707+i+Octagon Tube

R:15°



707+k+Octagon Tube

R:25°



707+r+Octagon Tube

R:30°



Haikou yulada trade co., ltd.



708+Octagon Tube



Octagon Tube

(ITEM NO) : Octagon Tube mm
(section) : 2 /3 /4
(small tube) : 19.4*9.9
(middle tube) : 23.2*13.7
(large tube) : 27*17.5
(outside tube) : 30.6*21.1



(Outside tube : iron/aluminum)



708+d+Octagon Tube 2



708+d+Octagon Tube 3



708+d+Octagon Tube 4

R:40



708+d+Octagon Tube



708+u+Octagon Tube



Haikou yulada trade co., ltd.



709+Octagon Tube



Octagon Tube

(ITEM NO) : Octagon Tube mm
(section) : 2 /3 /4
(small tube) : 19.4*9.9
(middle tube) : 23.2*13.7
(large tube) : 27*17.5
(outside tube) : 30.6*21.1



(Outside tube : iron/aluminum)



709+i+Octagon Tube 2 709+i+Octagon Tube 2 709+i+Octagon Tube 4



709+d+Octagon Tube



709+i+Octagon Tube

R:15



Haikou yulada trade co., ltd.



1707+Octagon Tube



Octagon Tube

(ITEM NO) : Octagon Tube mm
(section) : 2 /3 /4
(small tube) : 19.4*9.9
(middle tube) : 23.2*13.7
(large tube) : 27*17.5
(outside tube) : 30.6*21.1



(Outside tube : iron/aluminum)



1707+k+Octagon Tube 2 1707+k+Octagon Tube 1707+k+Octagon Tube



1707+g+Octagon Tube



1707+k+Octagon Tube

R:25



Haikou yulada trade co., ltd.



A7002+Octagon Tube

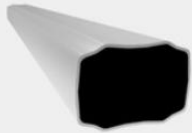

Octagon Tube

(ITEM NO) : Octagon Tube mm
(section) : 2 /3 /4
(small tube) : 19.4*9.9
(middle tube) : 23.2*13.7
(large tube) : 27*17.5
(outside tube) : 30.6*21.1



(Outside tube : iron/aluminum)



A7002+r+Octagon Tube 2 A7002+r+Octagon Tube3 A7002+r+Octagon tube 4



A7002+d+Octagon Tube A7002+u+Octagon Tube A7002+g+Octagon Tube
A7002+i+Octagon Tube A7002+k+Octagon Tube A7002+r+Octagon Tube



Haikou yulada trade co., ltd.



99+Octagon Tube



Octagon Tube

(ITEM NO) : Octagon Tube mm
(section) : 2 /3 /4
(small tube) : 19.4*9.9
(middle tube) : 23.2*13.7
(large tube) : 27*17.5
(outside tube) : 30.6*21.1



(Outside tube : iron/aluminum)



99+d+Octagon Tube 2



99+d+Octagon Tube 3



99+d+Octagon Tube 4



99+d+Octagon Tube



99+u+Octagon Tube



Haikou yulada trade co., ltd.



808+Octagon Tube



Octagon Tube

(ITEM NO) : Octagon Tube mm
(section) : 2 /3 /4
(small tube) : 19.4*9.9
(middle tube) : 23.2*13.7
(large tube) : 27*17.5
(outside tube) : 30.6*21.1

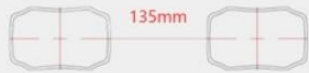

(Outside tube : iron/aluminum)



808+d+Octagon Tube 2

808+d+Octagon Tube 3

808+d+Octagon Tube 4



808+d+Octagon Tube



808+i+Octagon Tube



Haikou yulada trade co., ltd.



708+z+Rectangle Tube

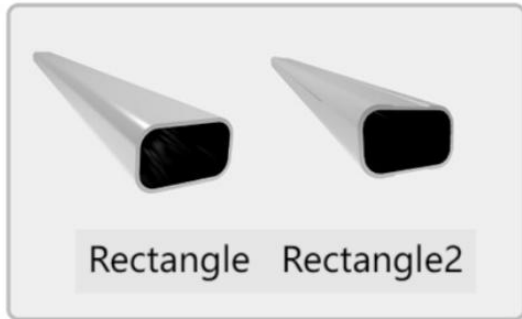

Rectangle Rectangle2

(ITEM NO) : Rectangle Tube mm
(section) : 2 /3
(small tube) : 20.4*12.4
(middle tube) : 24*16
(outside tube) : 27.6*19.6



708+z+Rectangle Tube



708+z+Rectangle Tube



(Outside tube : aluminum outside iron)



708+z+Rectangle Tube



Haikou yulada trade co., ltd.



A7002+Rectangle Tube

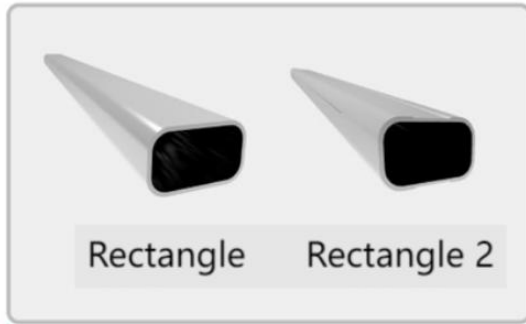

Rectangle Rectangle 2

(ITEM NO) : Rectangle Tube mm
(section) : 2 /3 /4
(small tube) : 20.4*12.4
(middle tube) : 24*16
(large tube) : 27.6*19.6
(outside tube) : 31.4*23.4



A7002+v+Rectangle Tube 2 A7002+v+Rectangle Tube 3 A7002+v+Rectangle Tube 4



(Outside tube : aluminum outside iron)



A7002+v+Rectangle Tube A7002+w+Rectangle Tube
A7002+209+Rectangle Tube A7002+z+Rectangle Tube



Haikou yulada trade co., ltd.



706+z+Rectangle Tube

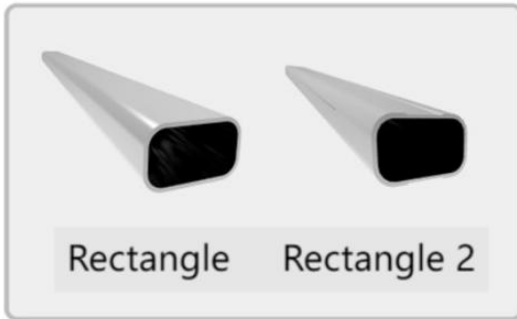

Rectangle Rectangle 2

(ITEM NO) : Rectangle Tube mm
(section) : 2 /3 /4
(small tube) : 20.4*12.4
(middle tube) : 24*16
(large tube) : 27.6*19.6
(outside tube) : 31.4*23.4



706+z+Rectangle 2 706+z+Rectangle 3 706+z+Rectangle 4



R:40



(Outside tube : aluminum outside iron)



706+z+Rectangle Tube

Haikou yulada trade co., ltd.



703+Rectangle Tube

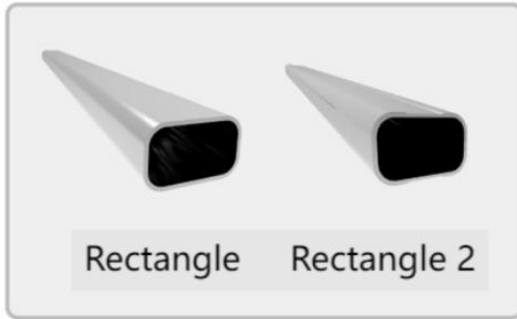

Rectangle Rectangle 2

(ITEM NO) : Rectangle Tube mm
(section) : 2 /3 /4
(small tube) : 20.4*12.4
(middle tube) : 24*16
(large tube) : 27.6*19.6
(outside tube) : 31.4*23.4



(Outside tube : aluminum outside iron)



703+w+Rectangle Tube 2



703+w+Rectangle Tube 3



703+v+Rectangle Tube



703+w+Rectangle Tube



703+209+Rectangle Tube



703+z+Rectangle Tube



Haikou yulada trade co., ltd.



507+Rectangle Tube

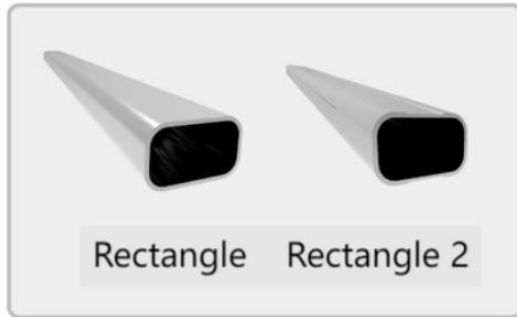

Rectangle Rectangle 2

(ITEM NO) : Rectangle Tube mm
 (section) : 2 /3 /4
 (small tube) : 20.4*12.4
 (middle tube) : 24*16
 (large tube) : 27.6*19.6
 (outside tube) : 31.4*23.4



507+v+Rectangle 2 507+v+Rectangle 3 507+v+Rectangle 4



135mm

(Outside tube : aluminum outside iron)

<p>507+R10(Phone Hold)+Rectangle Tube</p> <p>63.3</p>	<p>507+R10°+ Rectangle</p> <p>63.3</p>	<p>507+208 (Phone Hold)+Rectangle</p> <p>R:25°</p> <p>63.3</p>	<p>507+v+Rectangle</p> <p>R:25°</p> <p>63.3</p>	<p>507+v+Rectangle</p> <p>62.8</p>	<p>507+z+Rectangle</p> <p>71.1</p>
---	--	--	---	------------------------------------	------------------------------------



1908+Rectangle Tube

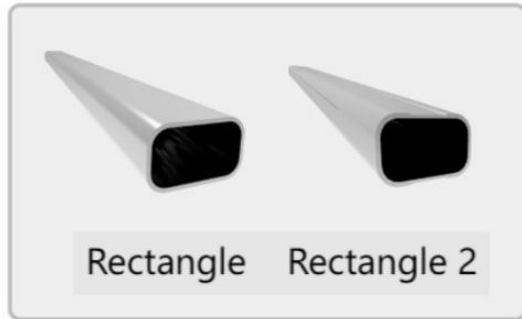

Rectangle Rectangle 2

(ITEM NO) : Rectangle Tube mm
(section) : 2 /3
(small tube) : 20.4*12.4
(middle tube) : 24*16
(large tube) : 27.6*19.6
(outside tube) : 31.4*23.4



(Outside tube : aluminum outside iron)



1908+z+Rectangle Tube 2



1908+z+Rectangle Tube 3



1908+290+Rectangle Tube 1908+w+Rectangle Tube 1908+z+Rectangle Tube



Haikou yulada trade co., ltd.



1905+z+Rectangle Tube

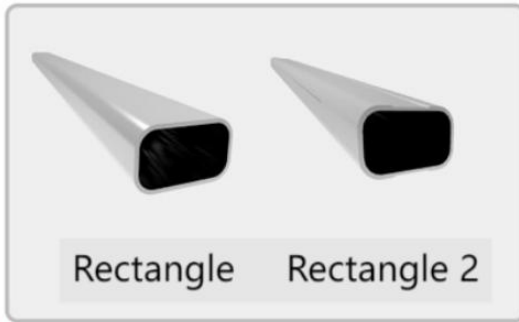

Rectangle Rectangle 2

(ITEM NO) : Rectangle Tube mm
(section) : 2 /3
(small tube) : 20.4*12.4
(middle tube) : 24*16
(large tube) : 27.6*19.6
(outside tube) : 31.4*23.4



1905+z+Rectangle Tube 2



1905+z+Rectangle Tube 3



135mm

(Outside tube : aluminum outside iron)



1905+z+Rectangle Tube

R:40

Haikou yulada trade co., ltd.



H1903+Rectangle Tube

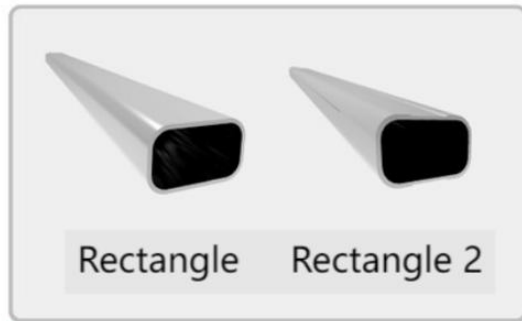

Rectangle Rectangle 2

(ITEM NO) : Rectangle Tube mm
(section) : 2 /3
(small tube) : 20.4*12.4
(middle tube) : 24*16
(large tube) : 27.6*19.6
(outside tube) : 31.4*23.4



H1903+Rectangle Tube 2 H1903+Rectangle Tube 3 H1903+Rectangle Tube 4



(Outside tube : aluminum outside iron)



H1903+Rectangle Tube



Haikou yulada trade co., ltd.



1903+y++Rectangle Tube

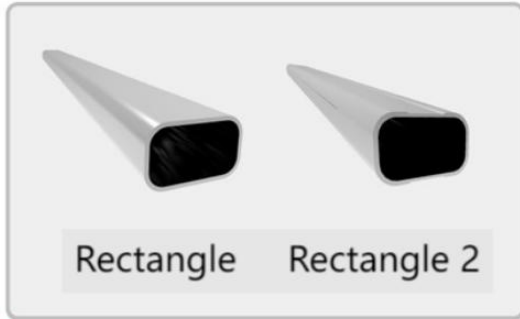

Rectangle Rectangle 2

(ITEM NO) : Rectangle Tube mm
(section) : 2 /3
(small tube) : 20.4*12.4
(middle tube) : 24*16
(large tube) : 27.6*19.6
(outside tube) : 31.4*23.4



1903+y+Rectangle Tube 2



1903+y+Rectangle Tube 3

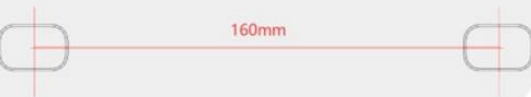

(Outside tube : aluminum outside iron)



1903+y+Rectangle Tube

R:22



Haikou yulada trade co., ltd.



1902+Rectangle Tube

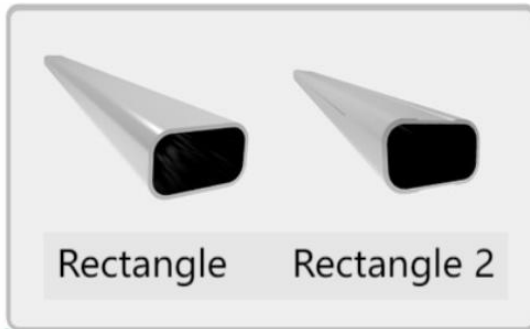

Rectangle Rectangle 2

(ITEM NO) : Rectangle Tube mm
(section) : 2 /3
(small tube) : 20.4*12.4
(middle tube) : 24*16
(large tube) : 27.6*19.6
(outside tube) : 31.4*23.4



1902+w+Rectangle Tube 2



1902+w+Rectangle Tube 3



1902+w+Rectangle Tube 4



(Outside tube : aluminum outside iron)



1902+209+Rectangle Tube



1902+w+Rectangle Tube

R:17



2303+Rectangle Tube

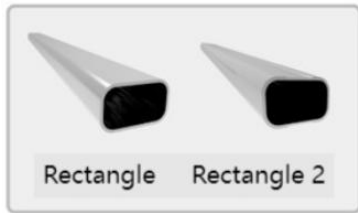

Rectangle Rectangle 2

(ITEM NO) Rectangle Tube mm
(section):2 /3
(small tube):20.4*12.4
(middle tube):24*16
(large tube):27.6*19.6



2303+Rectangle Tube 2+Frame 2303+Rectangle Tube 3+Frame



(Outside tube:iron/aluminum)

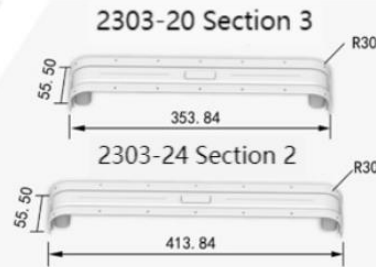

The middle pull pops up with one click

Haikou yulada trade co., ltd.

▶▶▶▶▶ 208+Rectangle Tube(USB+ Phone Holder)

Patent Number: 202222603922.4 / 202230497062.3

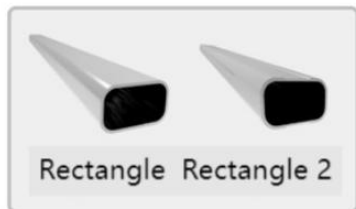

(ITEM NO): Rectangle Tube mm
(section): 2 / 3
(small tube): 20.4*12.4
(middle tube): 24*16
(large tube): 27.6*19.6
(large tube): 31.4*23.4



208+Rectangle tube 2 208+Rectangle Tube 3 208+Rectangle Tube 4

USB+ Phone Holder

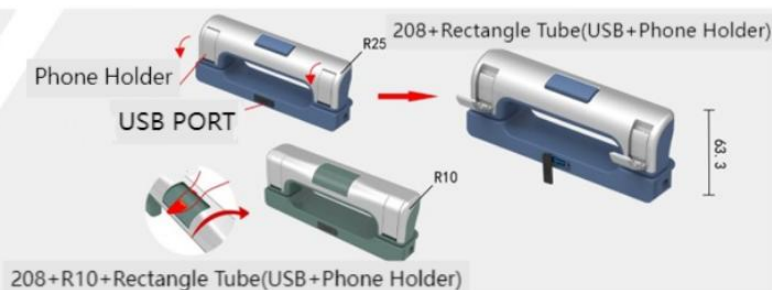

Haikou yulada trade co., ltd.



2012+Rectangle Tube

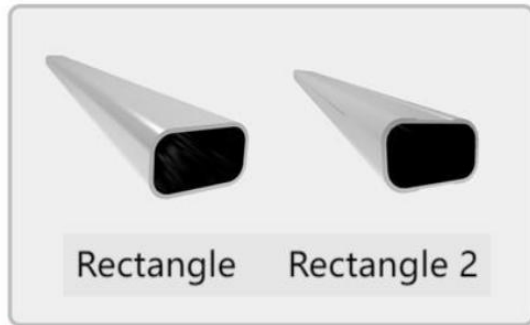

Rectangle Rectangle 2

(ITEM NO) : Rectangle Tube mm
(section) : 2 /3
(small tube) : 20.4*12.4
(middle tube) : 24*16
(large tube) : 27.6*19.6
(outside tube) : 31.4*23.4



2012+Rectangle Tube 2 2012+Rectangle Tube 3 2012+Rectangle Tube 4

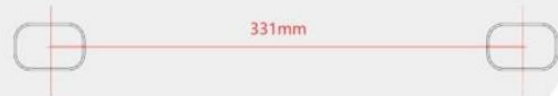

(Outside tube : iron/aluminum)



2012+Rectangle Tube



Haikou yulada trade co., ltd.



2112+Rectangle Tube

Patent Number: 202130783180.6

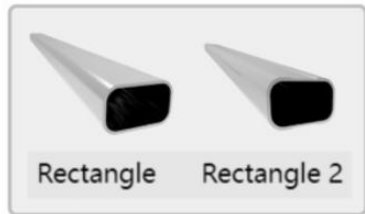

(ITEM NO) Rectangle Tube mm
(section): 2 / 3
(small tube): 20.4*12.4
(middle tube): 24*16
(large tube): 27.6*19.6



2112+Rectangle Tube 2

2112+Rectangle Tube 3



2112-20 Section 3



2112-24 Section 2

(Outside tube: iron/aluminum)

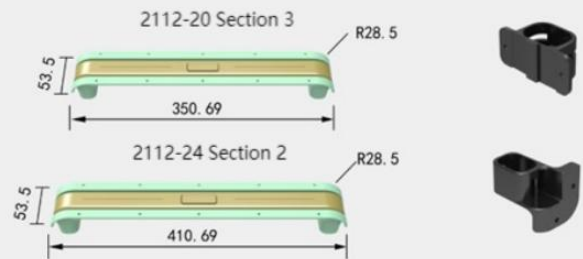

Haikou yulada trade co., ltd.



TROLLEY

- Aluminum alloy rod
- Strong and durable
- Customizable
- Smooth expansion





Luggage Lock

Contact Us



Lock E01



Model: E01
Size: 83*33*15 mm



Haikou yulada trade co., ltd.



Lock X05



Model: X05
size: 85*30*21 mm



Haikou yulada trade co., ltd.



Lock L02



Model: L02

Siz: 96*27*24 mm



Haikou yulada trade co., ltd.



Lock X01



Model: X01

Size: 85*30*21 mm



Haikou yulada trade co., ltd.



Lock MH21301



MH21301



Haikou yulada trade co., ltd.



Lock TSA21102

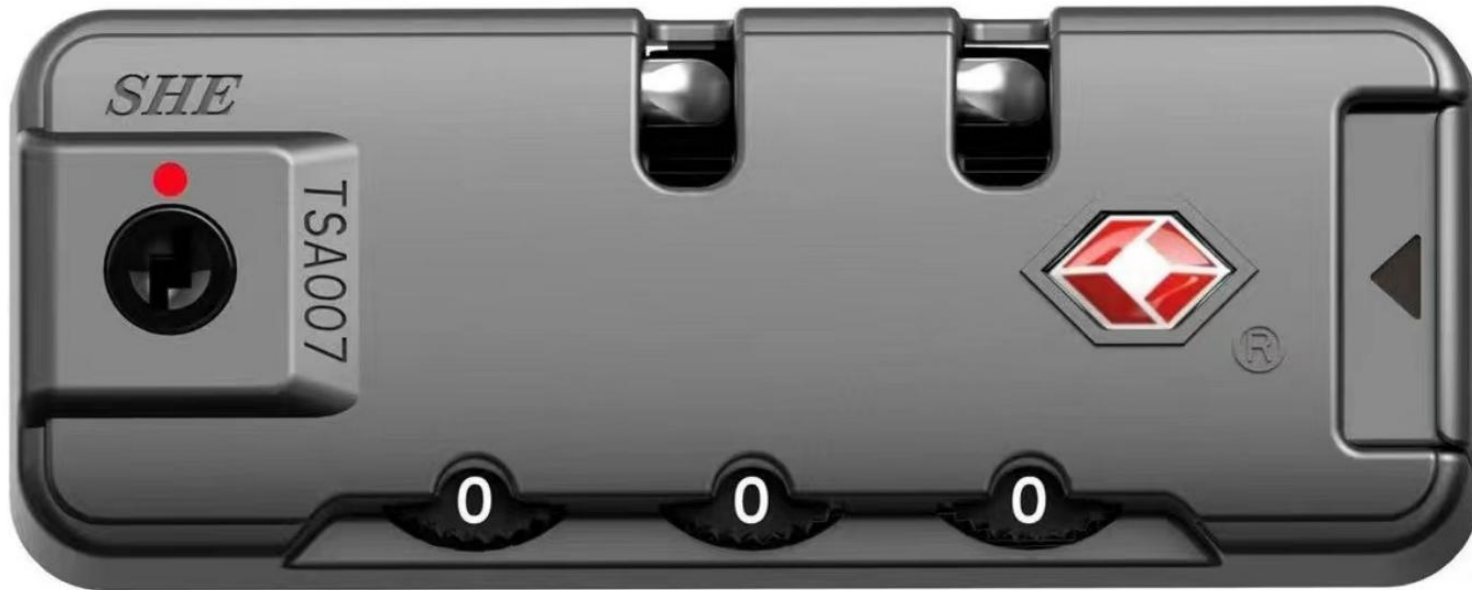

TSA21102



Haikou yulada trade co., ltd.



Lock TSA23301

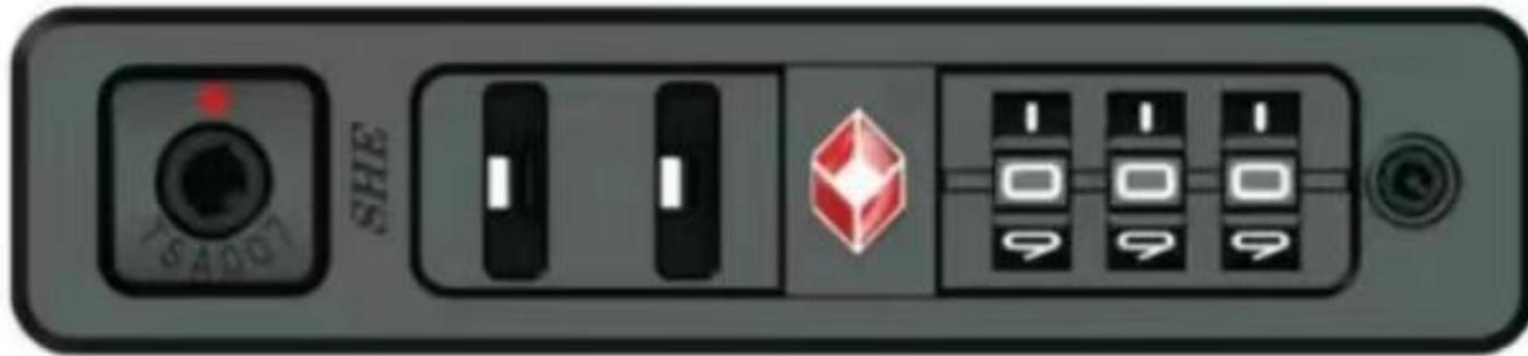

TSA23301



Haikou yulada trade co., ltd.



Lock TSA23100



TSA23100



Haikou yulada trade co., ltd.



Lock TSA23101



TSA23101



Haikou yulada trade co., ltd.



Lock TSA21101



TSA21101



Haikou yulada trade co., ltd.



Lock TSA23119



TSA23119



Haikou yulada trade co., ltd.



Lock TSA21103



TSA21103



Haikou yulada trade co., ltd.



Lock TSA21107



TSA21107



Haikou yulada trade co., ltd.



Lock TSA22001



TSA22001





Lock TSA22008



TSA22008

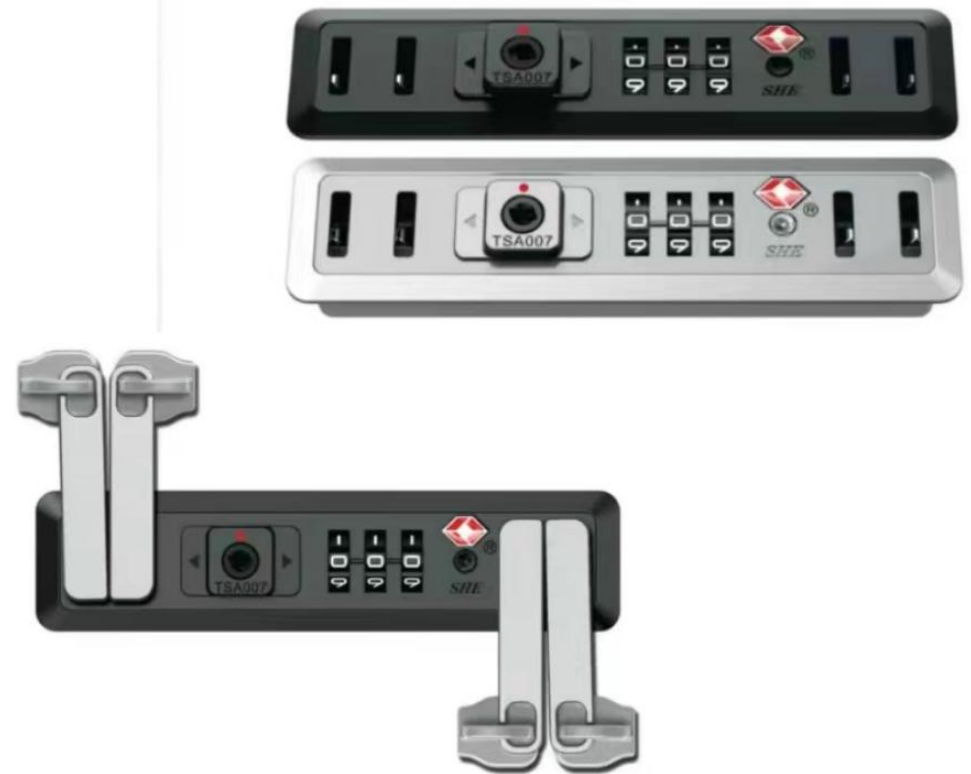

Haikou yulada trade co., ltd.



Lock TSA22010(USB)



USB



TSA22010



Haikou yulada trade co., ltd.



Lock TSA24302(USB)



USB



TSA24302



Haikou yulada trade co., ltd.



Haikou yulada trade co., ltd.



Accessories

PRODUCT SHOW

All Type Of Accessories



Haikou yulada trade co., ltd.



201 Water Cup Holder

201 Water Cup Holder

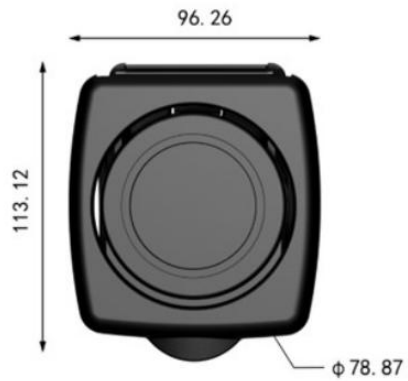

Haikou yulada trade co., ltd.



202 Water Cup Holder

202 Water Cup Holder



Haikou yulada trade co., ltd.



203 Water Cup Holder

203 Water Cup Holder



Haikou yulada trade co., ltd.



204 Water Cup Holder



Haikou yulada trade co., ltd.



YC001 Hidden Hinges



YC001 Hidden Hinges

46.61



21.96

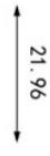

22.17



15



30



Haikou yulada trade co., ltd.



ABS Sheet & Mould



Haikou yulada trade co., ltd.



ABS Sheet & PP Mould

When it comes to ABS sheets and molds, they play a crucial role in various industries and applications.

Here's an introduction to ABS sheets and Mould.

ABS Sheet

ABS sheet commonly used in the construction of luggage. It's known for its durability, impact resistance, and lightweight properties, making it an ideal choice for protecting the contents of the luggage during travel. ABS sheets are also easy to clean and maintain, and they come in a variety of colors and finishes, providing a sleek and modern look for luggage design. Overall, ABS sheets help to make luggage more durable, functional, and stylish.

Imagine a material that's tough as nails but can also be shaped into almost any form you desire. That's ABS sheet for you! These sheets are versatile, lightweight, and have excellent impact resistance. They are commonly used because they are easy to cut, shape, and mold.

We have the best machines and experts to provide the best productions.



Haikou yulada trade co., ltd.



ABS Sheet & Mould

Luggage Mould

A mould for luggage is a crucial component in the manufacturing process, serving as a form or template to create the desired shape and design of the outer shell. Typically made of durable materials like metal or plastic, these molds are designed to fit specific dimensions and designs, ensuring consistency and accuracy in production. Whether used in injection molding for hard shell luggage or shaping and stitching for soft-sided luggage, these moulds are essential in creating the final product.

Our manufacturing process is top-notch, using the best injection machines, the best of the best Haitian, and ABS moulds supervised by our expert engineering team.

With over 30 years of experience, we can provide the best luggage parts and accessories for your projects. You can count on our durable and cost-effective ABS moulds, able to withstand high temperatures and ideal for mass production. Whether you need custom-shaped products or precision moulding, our dynamic duo of ABS sheets and moulds has got you covered.



Haikou yulada trade co., ltd.



ABS Sheet & Mould

- Place the ABS/PC sheet on the Vacuum forming machine with Aluminum mold.
- The style of shell is depending on the aluminum mold.
- The aluminum mold can be customized.(the 3D drawings of the aluminum mold are drawn before the customization.)

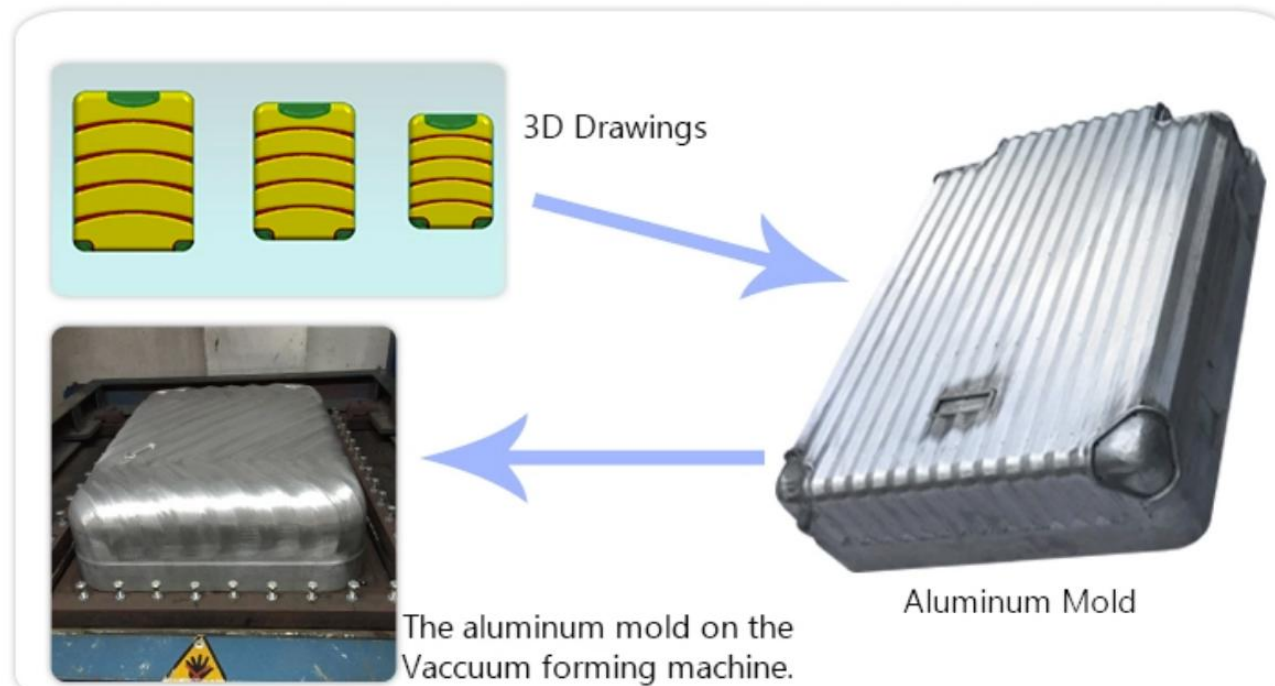



ORDERE PROCESS





Custom Processing

CASTER ACCESSORIES

- Smooth and super light • Silent shock absorption •
- Strong bearing capacity • Sturdy wheel frame •





TROLLEY

we keep up with market trends and quickly develop new products to meet both domestic and international demands in the fiercely competitive market. We believe that your trust and our strength will bring us joint success.

- ▶ Smooth stretching
- ▶ A variety of styles
- ▶ Support ODM & OEM

Contact Us

Haikou yulada trade co., ltd.



OEM&ODM / Source Manufacturers

SPECIALIZING IN THE PRODUCTION OF LUGGAGE ACCESSORIES

10+ years of professional production

- ▶ Complete styles
- ▶ Stable supply
- ▶ Quality assurance



Haikou yulada trade co., ltd.



BETTER TOGETHER / COOPERATION WITH GLOBAL CUSTOMERS



Haikou yulada trade co., ltd.



www.yulafactory.com

Haikou yulada trade co., ltd.